



**USE AND MAINTENANCE INSTRUCTIONS**

# **PELLET STOVE**

## **Hydro Hydro-ventilated**

Read instructions carefully before installation, use and maintenance  
The instruction manual is an integral part of the product

Laminox S.r.l. reserves the right to change the characteristics and data reported in the following document at any time and without warning in order to improve their products. This manual, therefore, cannot be considered as a contract with third parties.

The updated manuals and drawings are available on the website [www.laminox.com](http://www.laminox.com).

*Dear Customer, thank you for choosing one of our products, which is a result of technological expertise and our continuous quest for superior products in terms of safety, reliability and performance. This manual contains all the information and helpful tips for using your product with maximum safety and efficiency.*

## **IMPORTANT INFORMATION**

This manual has been prepared by the manufacturer and is an integral and essential part of the product. In the event of sale or transfer of the product, always ensure the presence of the manual as the information it contains is addressed to the buyer and to all those various people involved in the installation, use and maintenance of the product. Carefully read the instructions and information contained in this manual before installation, operation and maintenance of the product. The instructions contained in this instruction manual guarantee the safety of persons and property and ensure efficient operation and a longer service life. The manufacturer declines all responsibility for damage caused by failure to observe instructions regarding installation, use and maintenance listed in the instruction manual, for unauthorized modifications or non-original replacement parts. Product installation and use must be carried out in accordance with the manufacturer's instructions and in compliance with European, national and local regulations. Installation, electrical connection, functional testing, maintenance and repairs are operations that must be performed by qualified and licensed personnel who must have appropriate knowledge of the product. Product installation must not be carried out close to walls made of wood or combustible material. For proper installation, you must observe the "Safety distances" section. Verify the exact flatness of the floor where you will install the product. When handling the steel parts of the cladding, use clean cotton gloves to prevent leaving fingerprints difficult to remove for the first cleaning. Stove installation must be performed by at least two people. Connect the stove to the mains only after proper professional connection to the chimney flue. The power cable plug must remain accessible after installation of the stove. Only operate the stove with regulation wood pellets (refer to the "FUEL" chapter). Never use liquid fuels to operate the pellet stove or to stoke the embers present. Provide adequate ventilation in the installation area during operation. In the presence of operation failures, fuel supply will be interrupted. Re-start the unit after removing the cause of the failure. Discontinue use of the product in the event of failure or malfunction. Do not remove the safety guard located in the pellet tank. Any accumulated unburned pellets in the burner as a result of repeated failed ignitions must be removed prior to ignition. Pellet stove operation can cause very hot heating of the handles, the chimney flue and glass surfaces. Only touch these parts during operation when wearing protective clothing or with adequate aids. Because of the creation of heat on the glass, make sure that no persons unfamiliar with stove operation stand in the installation area. Inform children of the precautions to be observed during product operation and of possible dangers. In the event of problems or misunderstanding of the instruction manual, contact the dealer. Placing objects which cannot withstand heat on the stove or within the minimum required safety range is prohibited. Do not open the door during operation or operate the stove with its glass broken. For product terms, limitations and exclusions, please refer to the warranty included with the product. In order to pursue a policy of constant product development and renewal, the manufacturer may make changes to it as deems appropriate without notice. This document is the property of the manufacturer and cannot be disclosed in whole or in part to any third party without the written consent of the company, which reserves all rights according to the law.

## **DIRECTIVES AND REGULATIONS**

This product has been designed in accordance with the EN 14785:2006 standard and also complies with the following directives:

**2009/125/EC** (Ecodesign)

**2014/35/EU** (LVD – Low Voltage directive)

**2014 30/EU** (EMC – Electromagnetic Compatibility)

**2014/53/UE** (RED – Radio Equipment Directive)

**2011/65/EU** (ROHS)

<b>1</b>	<b>INSTALLATION.....</b>	<b>4</b>
1.1	General notes.....	4
1.2	Smoke discharge system .....	4
1.3	Smoke duct .....	5
1.4	Chimney of flue .....	5
1.5	Using an external fume duct.....	7
1.6	Chimney pot.....	7
1.7	External air intake vent.....	8
1.8	Installation room.....	9
1.9	Minimum safety distances .....	10
1.10	Flooring protection .....	11
1.11	Passing through combustible materials .....	11
<b>2</b>	<b>SPECIFICATIONS AND TECHNICAL DATA.....</b>	<b>12</b>
2.1	Specifications .....	12
2.2	Technical data.....	12
2.3	Product identification data .....	12
2.4	Electrical diagrams.....	12
<b>3</b>	<b>FUEL .....</b>	<b>13</b>
3.1	General notes.....	13
<b>4</b>	<b>ASSEMBLY.....</b>	<b>14</b>
4.1	General notes.....	14
4.2	Unpacking .....	14
4.3	Electrical connection .....	14
4.4	Water connection .....	15
4.5	Heating stove diagram .....	16
4.6	External thermostat installation .....	18
<b>5</b>	<b>USE .....</b>	<b>19</b>
5.1	Console description.....	20
5.2	First ignition.....	21
5.3	Ignition and normal operation .....	21
<b>6</b>	<b>MENU .....</b>	<b>26</b>
6.1	Menu 01 "WATER PRESSURE" .....	26
6.2	Menu 02 "CLOCK SET" .....	26
6.3	Menu 03 "CHRONO SET" .....	26
6.4	Menu 04 "CHOOSE LANGUAGE" .....	30
6.5	Menu 05 "STAND-BY MODE" .....	30
6.6	Menu 06 "BUZZER MODE" .....	30
6.7	Menu 07 "INITIAL LOAD" .....	30
6.8	Menu 08 "STOVE STATUS" .....	31
6.9	Menu 09 "TECHNICAL CALIBRATION" .....	31
6.10	Menu 10 "PELLET TYPE" .....	31
6.11	Menu 11 "FIREPLACE TYPE" .....	31
6.12	Menu 12 "FAN" .....	31
<b>7</b>	<b>SAFETY AND ALARMS.....</b>	<b>32</b>
7.1	Safety devices.....	32
7.2	Alarms.....	33
<b>8</b>	<b>WARNING AND MAINTENANCE .....</b>	<b>36</b>
8.1	Opening the door .....	36
8.2	Ash drawer cleaning.....	36
8.3	Brazier cleaning .....	36
8.4	Combustion chamber cleaning .....	36
8.5	Smoke chamber cleaning.....	37
8.6	Exhaust system cleaning.....	37
8.7	Cleaning metal and ceramic parts .....	37
8.8	Cleaning glass.....	37
8.9	Broken glass .....	37
8.10	Replacing the remote-control battery.....	37
8.11	Cleaning fans .....	37
8.12	Stove inactivity .....	38
8.13	Routine and special maintenance.....	38

# 1 INSTALLATION

## 1.1 General notes

The heating system or appliance must be installed in order not to damage the building and other systems. The installer must strictly comply with standard UNI 10683:2022 and all other applicable local regulations.

## 1.2 Smoke discharge system

Every device must be connected to a fume discharge system, which ensures dispersion of combustion products into the atmosphere.

The fume discharge system must meet the following requirements:

- The combustion products must be discharged from the roofs. Direct wall discharge or towards closed spaces, even in open air, is prohibited.
- The components must be made of material with A1 fire reaction class. In particular, the use of metal extendible and flexible hoses is prohibited.
- It must be ensured that the duct is completely sealed and correctly installed
- Tubes must **ALWAYS** be sealed with silicone (**no cementing**) that maintains resistance and elasticity characteristics at high temperature (250°C) and are to be secured with a Ø3.9mm self-tapping screw.
- Construction of the exhaust duct must be done by specialised personnel or companies, as reported in the following manual. Always create the exhaust system so that periodic cleaning is assured without having to dismantle any parts.
- The installation of dampers or valves which may obstruct the passage of exhaust fumes **is prohibited**.
- Installation in a chimney flue where exhausted fumes or vapours from other equipment (boilers, hoods, etc.) **is prohibited**.
- It should not be connected to any other fireplace, stove, boiler, or hood of any kind (*Fig. 1*).

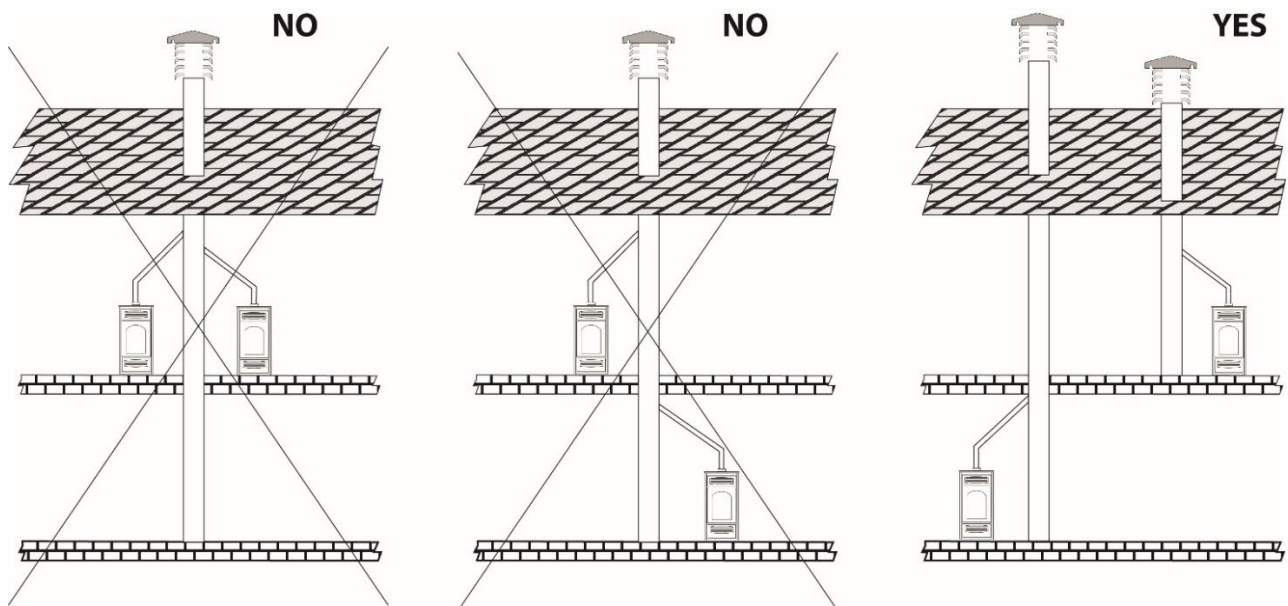

Fig.1

### 1.3 Smoke duct

The smoke duct is the pipe that connects the appliance to the Chimney

The smoke ducts must be installed in compliance with the following general requirements:

- If they pass inside unheated rooms or outside, they must always be insulated so as to have thermal resistance R not less than 0.12 m<sup>2</sup>K/W.
- They must not pass through rooms in which the installation of combustion appliances is forbidden
- They must not pass through rooms at risk of fire or rooms that cannot be inspected
- They must be installed in such a way as to allow for normal thermal expansion
- Along their entire length, they must have a diameter no less than that of the attachment of the appliance's evacuation duct
- They must allow the recovery of soot and be inspectable
- They must be equipped with an element with a sampling hole in accordance with UNI 10389-2
- The use of flexible metal pipes to connect the appliance to the chimney is not permitted

### 1.4 Chimney of flue

Each appliance must have its own flue with the following characteristics:

- Must have a section equal to or greater than the diameter of the fume exhaust pipe of the stove and a height no less than the one stated (see table 1)
- Must operate in negative pressure
- The internal section must be uniform, preferably circular: the square or rectangular sections must have rounded corners with a radius of no less than 20 mm, maximum ratio between the sides of 1.5, walls as smooth as possible and without restrictions, curves must be regular and seamless, deviations from the axis no greater than 45° (Fig. 2).
- It must not have more than two changes of direction with slopes not exceeding 45°
- It must be used exclusively for the evacuation of combustion products
- It must have a mainly vertical course and be free from any bottleneck along their entire length
- It must have a draft that complies with the indications in the product's **technical data sheet**
- It must be properly spaced from combustible or flammable materials through an air gap or suitable insulating material.
- Creating fixed or mobile apertures on the chimney flue to connect equipment other than auxiliary devices is prohibited.
- Passing other air supply channels and piping for utilities through the chimney flue, however large, is prohibited.
- The chimney flue should be equipped with a collection chamber for solid materials and any condensate, located below the mouth of the flue, so as to be easily opened and inspected from an airtight door.
- Whenever using parallel output chimneys, it is advisable to raise a bracing element. (Fig.6)

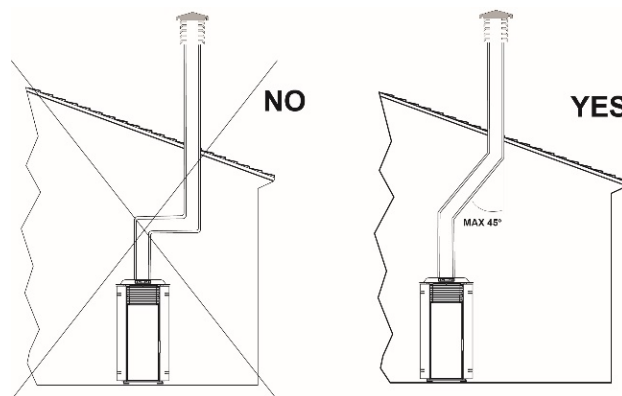

Fig.2

### 1.4.1 Maximum usable lengths

Painted aluminised steel tubes (minimum thickness 1.5 mm), stainless steel tubes (Aisi 316) or porcelain tubes (minimum thickness 0.5 mm) with a nominal diameter of **80 mm** or **100 mm** (for tubes inside the chimney flue max 150 mm) can be used.

Flexible hoses are permitted if they fall within the limits prescribed by law (in stainless steel with smooth inner wall). The male-female connection collars must be at least 50 mm long.

Tube diameter depends on the type of system. The stove has been designed for Ø 80 mm and Ø 100 mm tubes (check the technical data sheet of the selected model). As can be seen in the table below, a double-wall Ø 100 mm tube may be necessary in some cases and models.

TYPE OF SYSTEM	WITH Ø 80 mm TUBE	WITH DOUBLE-WALL Ø 100 mm TUBE
Minimum length	1.5 m	2m
Maximum length (with 3 90° curves)	4.5 m	8m
For installations situated over 1200 m above sea level	-	mandatory
Maximum number of curves	3	4
Horizontal sections with min. 5% incline	2m	2m

Tab.1

**NOTE: load losses of a 90° curve can be equated with those of 1 metre of tube; the serviceable T-connection is to be considered as a 90° curve.**

### 1.4.2 Using an existing chimney flue

If you wish to use an already existing chimney flue, it is advisable to have it checked by a professional chimney sweep to ensure that it is watertight. This is because fumes, being slightly pressurised, could infiltrate cracks in the chimney flue and invade living spaces. If an inspection finds that the chimney flue is not perfectly intact, it is advisable to intubate it with new material. If the existing chimney is large, we recommend inserting a tube with a maximum diameter of 150 mm. It is also advisable to insulate the fume exhaust duct. Figs. 3 and 4 demonstrate the solutions to adopt if you want to use an existing chimney flue.

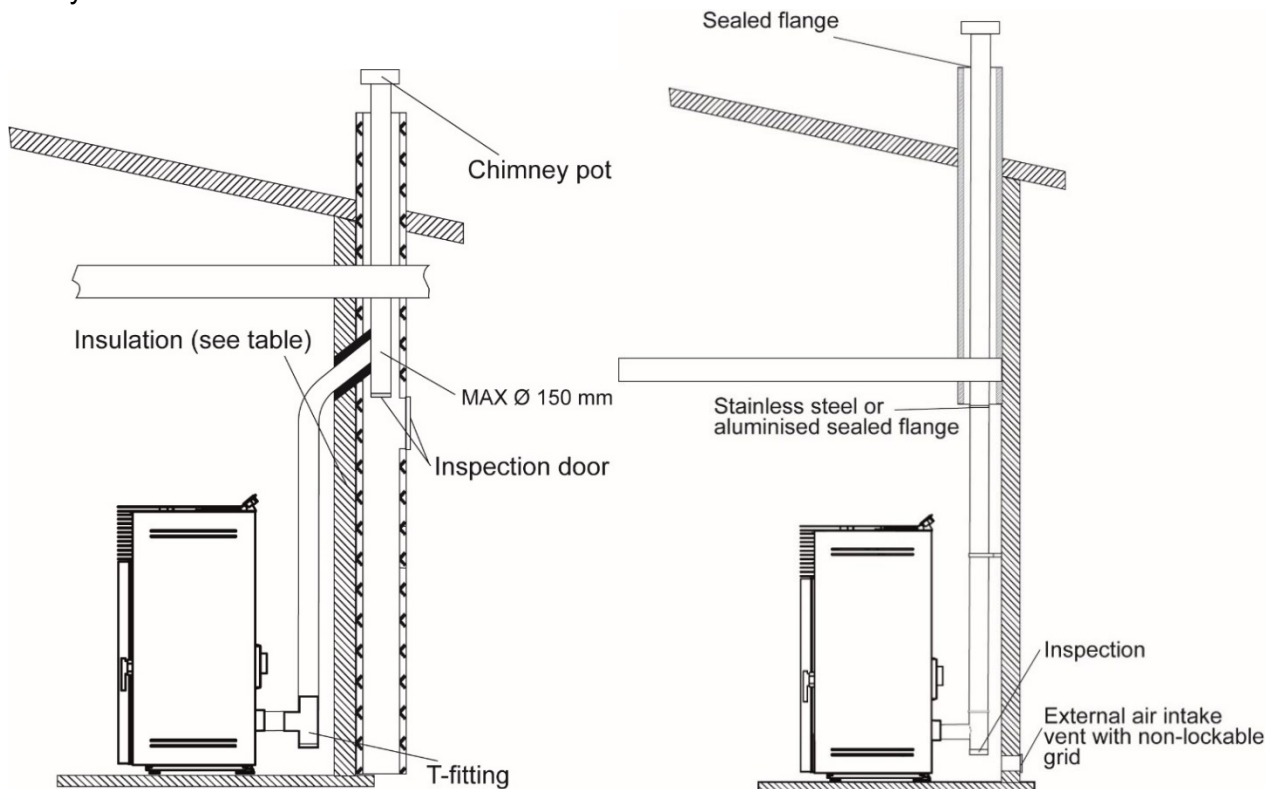

Fig. 3

Fig. 4

## 1.5 Using an external fume duct

An external fume duct can be used only if it meets the following requirements:

- Only insulated tubes (**double wall**) in stainless steel, secured to the building (*Fig.5*) should be used.
- An inspection area should be created at the base of the duct for performing periodic checks and maintenance.
- It should be equipped with a windproof chimney pot and observe the distance "d" from the ridge of the building as described in par. 1.6.

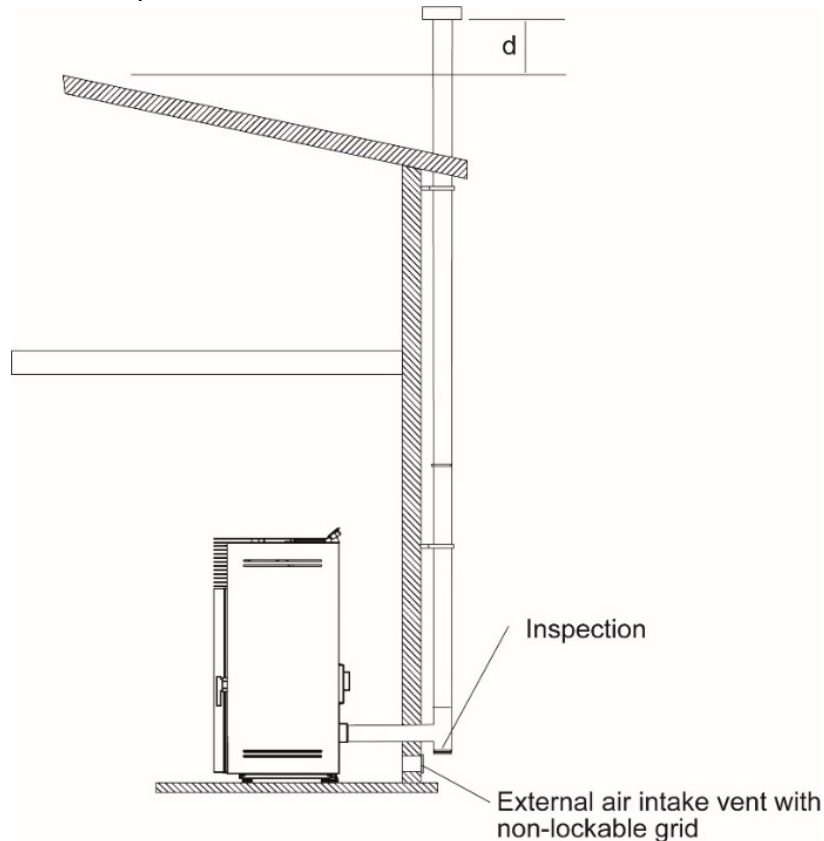

Fig. 5

## 1.6 Chimney pot

The top of the chimney flue must be equipped with a device, called a chimney pot, which facilitates dispersion into the atmosphere of combustion products.

The chimney pot must meet the following requirements:

- Its internal section and shape must be equivalent to that of the chimney flue.
- Have a useful outlet section no less than double that of the chimney flue.
- Chimney pots that emerge from the roof or which remain in contact with the outside (for example in the case of an open loft), must be covered with brick elements and well isolated. It must be constructed so as to prevent penetration into the flue of rain, snow, or foreign bodies and so that, in the event of winds in any direction and at any angle, it assures the discharge of combustion products (windproof chimney pot).
- The chimney pot must be positioned so as to guarantee an adequate dispersion and dilution of combustion products and, in any case, outside the zone of reflux. This zone can be different sizes and shapes depending on the angle of slope of the roof, so it is necessary to adopt the minimum heights shown in *Fig.7* and *Fig.8*.
- The chimney pot must be of windproof and exceed the height of the ridge, (*Fig.7* and *Fig.8*).
- Any buildings or other obstacles that exceed the height of the chimney pot must not be close to the chimney pot itself (*Fig.7*).

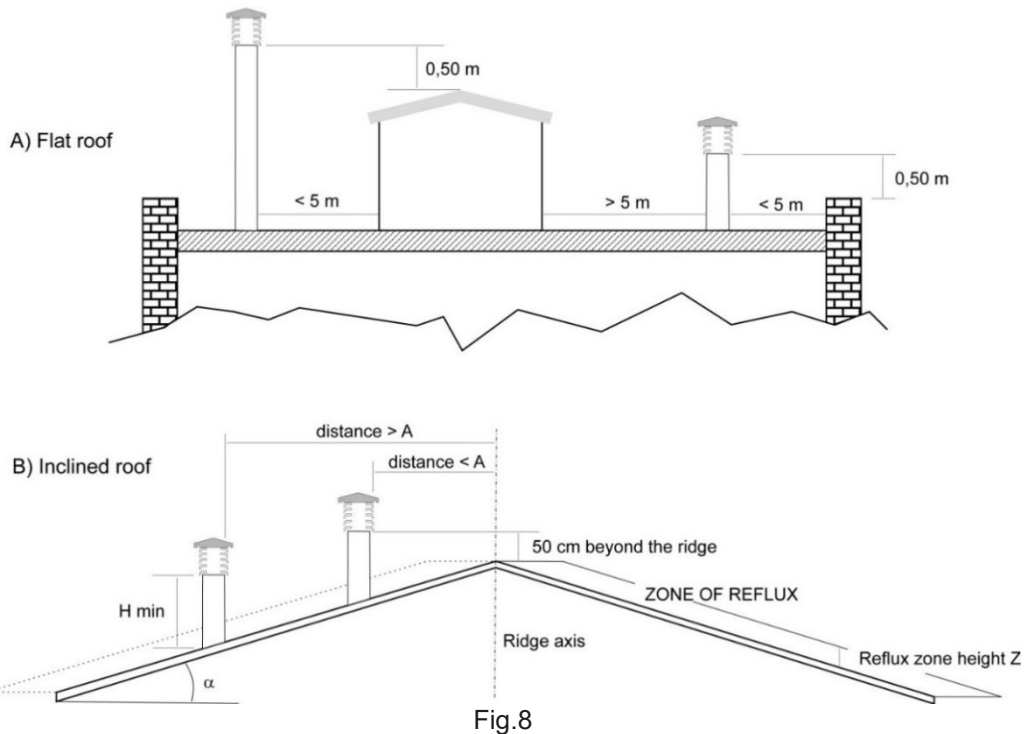
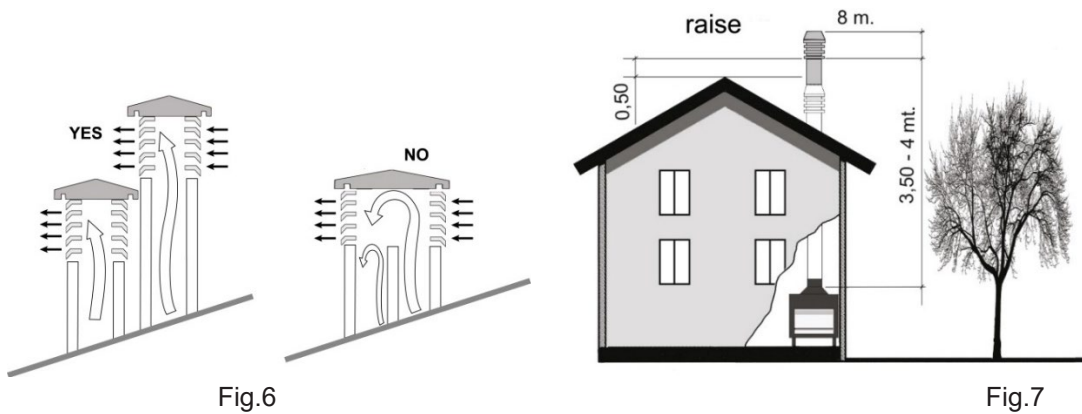

## 1.7 External air intake vent

The stove must have the air necessary to ensure smooth combustion operation and good environmental well-being.

Make sure that the room where the stove is installed offers sufficient ventilation and install an air supply duct from the outside with the recommended minimum section of **100 cm<sup>2</sup>**.

Ventilation openings are not required:

- In the case of an airtight installation
- If the room has permanent permeability to external air which ensures that under any conditions a depression greater than -4 Pa does not occur

**Ventilation opening:**

- They must be positioned close to the floor
- They must be made so as to make maintenance operations possible
- They must be protected by grids, metallic nets, etc., without reducing their net useful section

In the case of a closable vent, this must be:

- Normally open
- Open automatically when the appliance is turned on



### 1.7.1 Direct Vent

Direct ventilation must be achieved via ventilation openings directly in the installation room of the appliances

### 1.7.2 Indirect vent

Air flow can also be obtained from a room adjacent to the installation room, provided that this flow can be carried out freely through permanent, non-closable openings communicating with the outside.

In case of passage through several rooms, the net section of the ventilation opening must be doubled at each passage

With respect to the installation room, the adjacent room should not be put under vacuum with respect to the external environment as a result of a reverse draft caused by the presence in this space of another utility device or suction device. The room adjacent to the permanent openings must meet the requirements set out in the paragraphs above. The adjacent room cannot be used as a garage, for storage of combustible material or for activities involving a risk of fire

## 1.8 Installation room

- Installing the device inside rooms at risk of fire is prohibited.
- **Outdoor installation** in locations exposed to weathering or humid areas **is prohibited**.
- In bathrooms, bedrooms and studios can be installed only airtight appliances with external ducted combustion air intake.
- Stove installation must be carried out in a location which allows safe and easy use and simple maintenance. Said location must also be equipped with electrical grounding as required by law.

### 1.8.1 Preventing house fires

- The installation room must not be at risk of fire or used as a warehouse for combustible material. The storage of solid fuel for a maximum volume of 1.5 m<sup>3</sup> is permitted in the room where the appliance is installed
- The fireplace connecting tube must never pass through a combustible surface
- It is also advisable to maintain all combustible elements or flammable material such as beams, wooden furniture, curtains, flammable liquids, etc. outside the radiation area of the furnace and at a distance of at least 1 m from the heating block.
- In the event that the surrounding space has coverings in combustible or heat-sensitive material, a protective membrane made of non-combustible insulating material must be interposed. If the flooring is made of combustible material, a non-combustible protective material that protrudes laterally and frontally from 15 cm to 30 cm must be provided at the mouth of the furnace.

*For further information, refer to local requirements.*

**CAUTION:** when a fume exhaust pipe passes through a wall or ceiling, particular installation methods must be applied (protection, thermal insulation, distances from heat sensitive materials, etc.).

### 1.8.3 Installation in presence of several appliances

The following table shows the possible installation configurations of several appliances in the same room or in adjoining rooms

	Biomass appliance with non-airtight installation	Biomass appliance with airtight installation	Type A Gas appliance	Type B Gas appliance	Type C Gas appliance	Gas cooking appliances
Biomass appliance with non-airtight installation	Admitted in compliance with UNI 10683	Allowed	Forbidden	Forbidden	Allowed	Allowed
Biomass appliance with airtight installation*	Allowed	Allowed	Allowed	Allowed	Allowed	Allowed

Tab.2

\* An airtight installation does not consume the oxygen of the room by taking all the air from outside (if suitably ducted) and allows the product to be installed inside all houses that require a high degree of insulation such as “passive houses”. Thanks to this technology there is no risk of smoke emissions into the room and there is no need for air intakes in the installation room.

### 1.8.4 Minimum volume of the installation room

To calculate the minimum volume of the installation room, the formula

**Room Volume = 10 x Appliance Power** must be used

Room Volume is expressed in m<sup>3</sup> and Appliance Power is expressed in kW and is equal to:  
**Rated Thermal Power – Water Thermal Power**

### 1.8.5 Capacity of the floors of the installation room

The floor of the installation room must have a capacity suitable for supporting the total weight of the appliance

## 1.9 Minimum safety distances

The following figures show the minimum safety distances which must always be guaranteed.

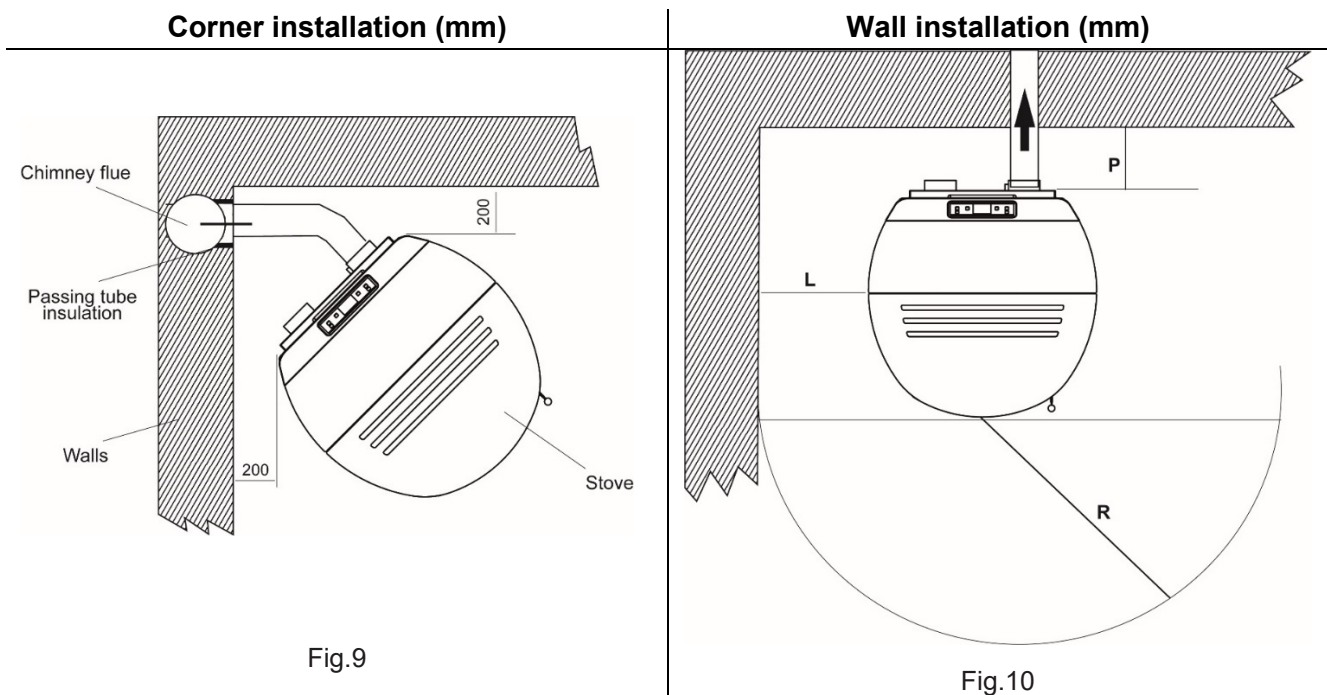

### Safety distances from flammable material

Minimum distance in air from the flammable rear wall

Minimum distance in air from the flammable side wall

Frontal distance from flammable material

**P= 200 mm**

**L= 200 mm**

**R = 1000 mm**

**Distance from flammable ceilings and false ceilings (mm)**

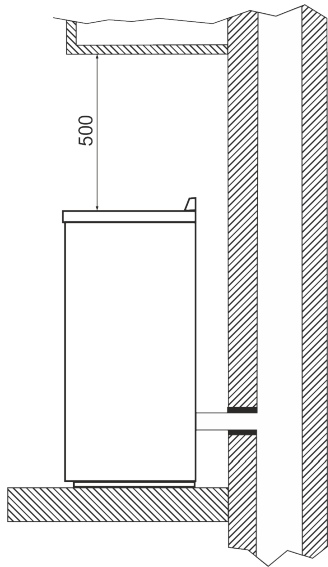

Fig. 11

**Distance of fume exhaust system from flammable walls (mm)**

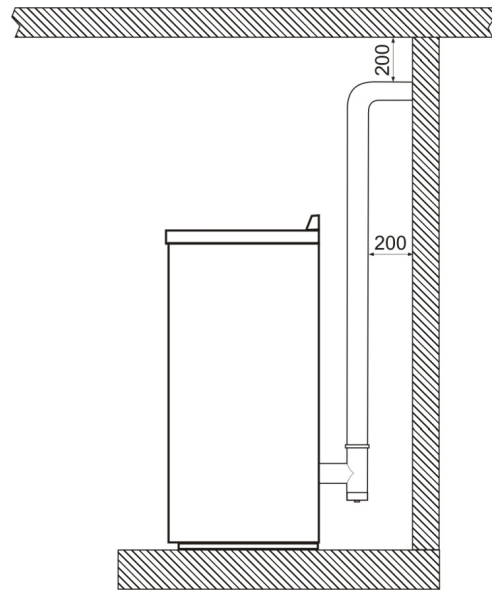

Fig. 12

**1.10 Flooring protection**

In the event of valuable flooring or flooring that is sensitive to heat, moisture or is flammable, a floor protection must be used (i.e. sheet steel, marble or tile slabs). Whichever type of protection selected, it must protrude at least 300 mm from the front, at least 150 mm from the sides of the stove, must withstand the weight of the stove and have a thickness of at least 2 mm (Fig. 13 and 14).

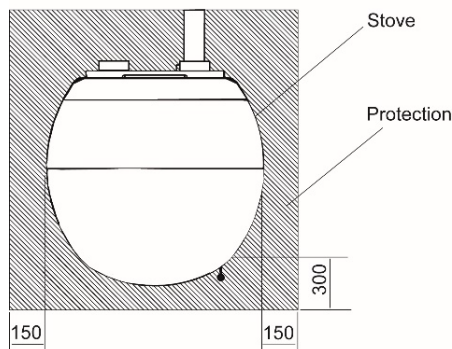

Fig. 13

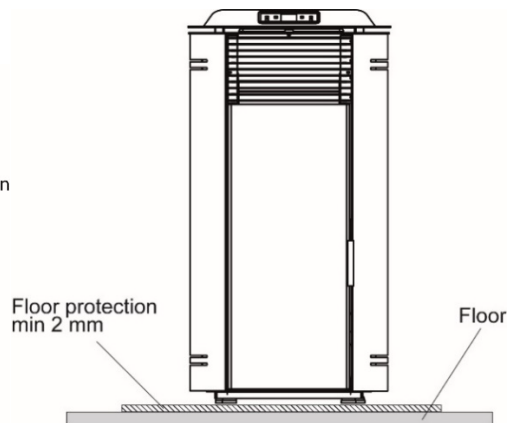

Fig. 14

**1.11 Passing through combustible materials**

Once the location of the stove has been decided, you will have to drill the hole for passage of the fume exhaust tube. This varies depending on the type of installation (therefore on the exhaust tube diameter) and on the type of wall or roof to be crossed (table 3). The insulator must be of mineral origin (rock wool, ceramic fibre) with a nominal density greater than 80 kg/m<sup>3</sup>.

	Insulation thickness [mm]	Fume exhaust tube diameter [mm]	
		Ø80	Ø 100
		Diameter of holes to be created [mm]	
Wooden wall, or wall which is flammable or has flammable parts	100	280	300
Concrete wall or roof	50	180	200
Brick wall or roof	30	140	160

Tab.3

## 2 SPECIFICATIONS AND TECHNICAL DATA

### 2.1 Specifications

Pellet stoves are devices built to work with good quality wood pellets only (see par. 3 fuel).

### 2.2 Technical data

The technical data of the individual models can be found on the website [www.laminox.com](http://www.laminox.com)

### 2.3 Product identification data

The technical label shows device data and performance. Tampering with, removing or lack of a technical label makes installation and maintenance operations difficult, due to the lack of product identification. In the event of damage, request a duplicate from our service centre. Given the importance of the data label, we recommend installing the stove at a distance at which it is always visible.

### 2.4 Electrical diagrams

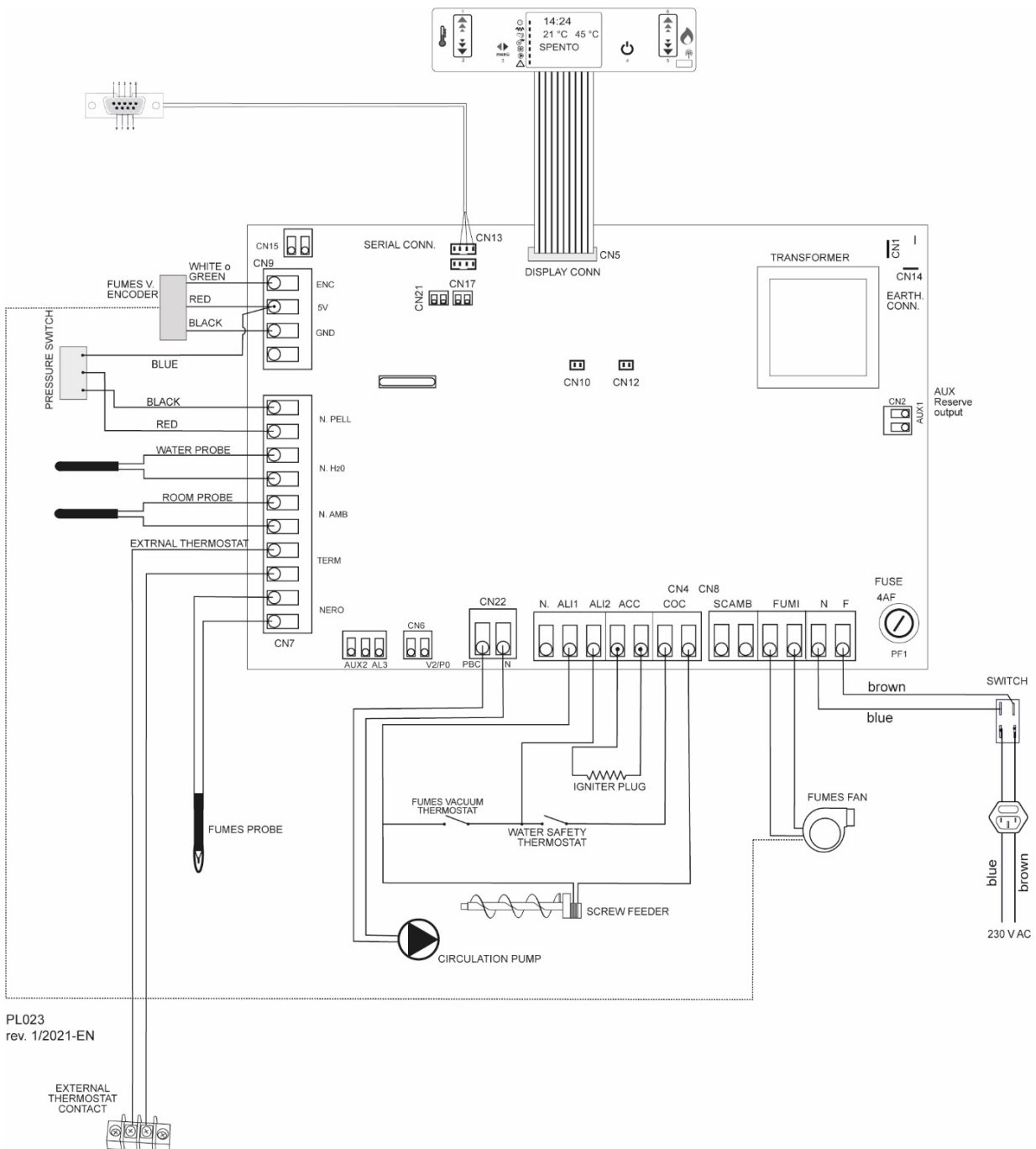

## 3 FUEL

### 3.1 General notes

**The pellet stove is designed to burn wood pellets only.**

*Wood pellets are a fuel obtained from the pressing of sawdust timber, extracted from the processing and transformation residues of dried wood material. The compactness of the product over time is guaranteed by a natural origin substance contained in the wood: lignin. The typical small cylinder form is obtained by extrusion.*

*Various types of pellets with quality and characteristics that vary depending on the processing and type of wood species used are available on the market.*

**CAUTION: Always use certified quality wood pellets: i.e. DIN, DIN PLUS, ÖM 7135, Pellet Gold, Catas etc. The company does not guarantee proper stove functioning with the use of low-quality pellets.**

Stoves and heating stoves are tested and programmed to ensure good performance and perfect quality operation with specific characteristic pellets:

Components:	Wood
Length:	< a 30 mm
Diameter:	6-6.5 mm
Lower calorific value :	4,8 kWh/kg
Humidity rate:	< a 8 %
Residual ash :	< a 0,5 %

GOOD QUALITY pellets are smooth, shiny, slightly dusty and with regular length.

LOW QUALITY pellets are of varied lengths, dusty with vertical and horizontal splits.

**Since pellet characteristics and quality greatly influence the autonomy, efficiency and proper operation of the stove, we recommend:**

**AVOID** using pellets with dimensions different from that described by the manufacturer.

**AVOID** using low quality pellets or pellets containing dispersed sawdust powder, resins or chemicals, additives or adhesives.

**AVOID** using moist pellets.

The use of unsuitable pellets causes:

- clogging of the brazier and fume discharge ducts
- increased consumption of fuel
- decreased efficiency
- no guarantee of normal stove operation
- dirtying of glass
- production of unburned granules and heavy ash

The presence of moisture in pellets increases the volume of the capsules and crumbles, causing

- feeding system malfunctions
- poor combustion

Pellets should be stored in a dry and sheltered place. Particular attention should be given to the handling of the bags to prevent their crushing, resulting in the formation of sawdust.

Stove operation parameters may have to be altered when using quality pellets with dimensional and calorific characteristics different from those indicated. Contact an authorised service centre if necessary.

**THE USE OF POOR-QUALITY PELLETS NOT IN ACCORDANCE WITH MANUFACTURER'S INSTRUCTIONS NOT ONLY DAMAGE THE STOVE AND COMPROMISE PERFORMANCE BUT MAY RESULT IN FORFEITURE OF THE WARRANTY AND COMPANY LIABILITY.**

## 4 ASSEMBLY

### 4.1 General notes

Here are some general recommendations to follow in order to prevent accidents or damage to the product:

- Unpacking and installation must be performed by at least two people.
- **All handling operations must be carried out using appropriate means and in full compliance with safety regulations.**
- The positioning of the packed product must be maintained in accordance with the guidelines supplied by pictograms and written on the packaging.
- If using ropes, straps, chains, etc., make sure they are suitable for the weight to be unloaded and are in good condition.
- When moving the package, move with slow and continuous movements to avoid tearing ropes, chains, etc
- Do not tilt excessively in order to avoid overturning.
- Do not stand within range of the loading/unloading means (forklifts, cranes, etc.).

### 4.2 Unpacking

Unpack the product being careful not to damage or scratch it. Remove the accessory package and any pieces of polystyrene or cardboard used to block removable parts, etc. from the stove furnace. Take out the envelope with the user manual and the guarantee usually placed either in the combustion chamber or in the pellet tank.

Also remember not to leave packaging components (plastic bags, polystyrene, etc.) within the reach of children, as they could be potential sources of danger. Dispose of them according to regulations

### 4.3 Electrical connection

The stove is supplied with a power cable that must be plugged into a 230V 50Hz outlet.

Outlet connection in the rear of the stove is illustrated in *Fig. 15*.

Absorbed power is indicated in the product technical sheet, which can be downloaded from the website [www.laminox.com](http://www.laminox.com).

By law, the system must be properly grounded and with a differential circuit-breaker. Make sure that the electrical power cable does not come into contact with hot parts when set in its final position.

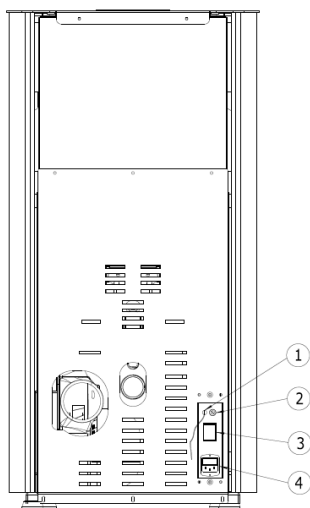

Fig. 15

1. Room probe
2. Safety thermostat
3. Main switch
4. Power socket

**CAUTION: Ensure that the plug for the electrical connection remains accessible after stove installation**

## **4.4 Water connection**

**Connection of the stove to the hydraulic system must be exclusively performed by qualified personnel, who is able to perfectly perform the installation, complying with the regulations in force in the Country of installation.**

If the installation of the stove requires interaction with another pre-existing system equipped with another heating device (gas boiler, methane boiler, gasoline boiler, etc.), contacting qualified personnel able to respond to the conformity of the system, according to the requirements of the law in force regarding the subject, is more recommended.

**The company denies any liability in case of damages to property or persons or in case of no or incorrect operation if the aforementioned warnings are not complied with.**

**CAUTION:** To connect the delivery pipe, return pipe, refilling pipe and drains arrange flexible hoses at least 70 cm long and shut-off shutters in order to isolate the machine from the water system should moving it to perform routine/special maintenance be required.

**CAUTION:** Connect the thermal safety drain of the machine to an appropriate drain funnel with no shut-off valves. In case of thermal safety drain valve operation, the water must be free to flow without causing damage to persons and built-up area.

When the instrument is fully operational it produces hot water at a temperature necessarily lower than the boiling one and therefore the thermal system must be designed in compatibility with the machine specifications.

During installation and operation take into account that disposal of the minimum power delivered by the machine must be ensured.

**Make sure that the thermal hydraulic system is fitted with an additional and adequate closed appropriately dimensioned expansion vessel.**

For the installation of an additional expansion vessel take into account that usually 1 litre of vase compensated 10 litres of system and at least 1 litre is always dedicated to the water inside the stove. The expansion vessel inserted inside the device is pre-charge at the pressure indicated in the plate, adjust the pre-charged pressure of the expansion vessels to the operating pressure of the thermal system.

**We recommend installing a 1" anti-condensation valve with 55 °C opening and softener systems.**

### **4.4.1 System filling**

**Before performing the stove connections thoroughly wash the thermal system** (pipes, heating bodies, etc.) with appropriate paint or deposit removers able to remove any residues which may compromise the correct operation of the stove.

Hydraulic connections must be performed rationally using the connections of the stove. The stove safety valve drain must be connected to a drain funnel. Otherwise, if the drain valve operates flooding the room, the stove manufacturer shall not be deemed responsible.

We recommend filling the system at a pressure of 1.0 - 1.2 bar (pressure is shown with the b symbol on the stove display) the stove can still function from 0.6 bar to 2.5 bar before going into alarm

In case of installation in spaces where temperature may drop below 0°C, inserting appropriate antifreeze in the system is required since the stove does not have an automatic antifreeze system.

#### 4.4.2 Indications for water treatment

To prevent the heating system from having to be regularly cleaned it is best to **install a magnetic sludge remover**, this filter aids routine maintenance, increases stove life span, aid removal of impurities and increased global efficiency of the system.

The magnetic sludge remover **filters the heating system** removing sludge, ferrous or sandy residues which circulate in the pipes, if not removed they create surfaces which do not permit heat transmission, consequent pellet consumption and possible stove malfunction.

**CAUTION:** In the case of water with PH >8, aluminium gaskets must not be used

#### Thermostoves with domestic hot water production

If the water hardness of your home is higher than 15°f, **it is mandatory to install a softening system and a filter upstream.** *Make sure that the micrometry of the filter and the softener are compatible.*

If the water hardness is less than 15°f it is sufficient to install a polyphosphate dispenser

We recommend having the exchanger undergo yearly maintenance to remove limestone sediments and mineral salts.

*It is best to keep in mind that deposit drastically lower performance due to their extremely low thermal conductivity.*

#### 4.5 Heating stove diagram

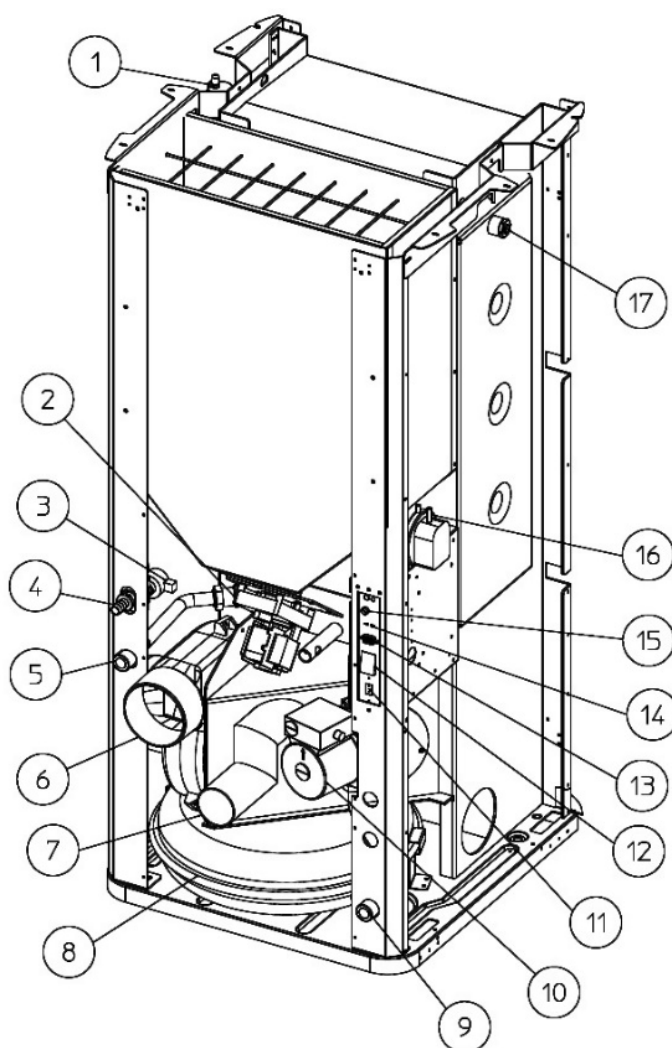



1	Jolly Valve	2	Pellet gear motor	3	Pressure switch	4	Vent safety
5	System delivery	6	Flue gas motor	7	Primary air inlet	8	Expansion vessel
9	System return	10	Circulation pump	11	Power supply outlet	12	Main switch
13	Serial port	14	External sensor clamp	15	Manual reset	16	Vacuum thermostat
17	Probe well						

#### 4.5.1 Indicative hydraulic diagram heating only

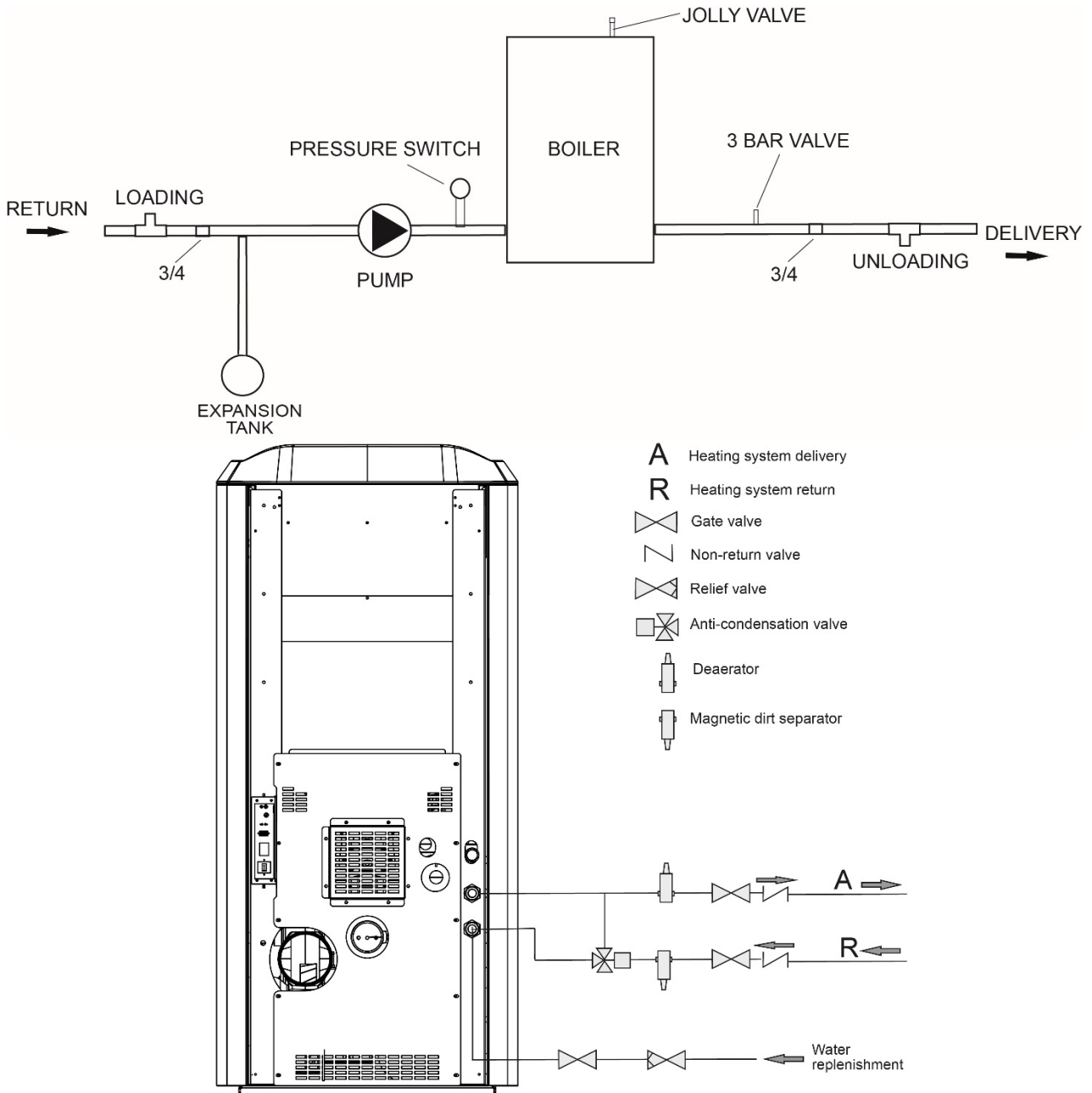

## 4.6 External thermostat installation

Stove operation can be adjusted to any external room thermostat connected to the circuit board with a clean contact (see electrical diagram). The thermostat connection is made using a 2x0.5 mm<sup>2</sup> cable. The contact to be used is of the NO (Normally open) type, if there isn't a clean contact, insert a relay between the thermostat and the machine terminal board.

**The connection of unsuitable thermostats could irreparably damage the electronic card.**

**This operation should be performed by qualified personnel.**

The external thermostat works in parallel to the internal thermostat of the stove.

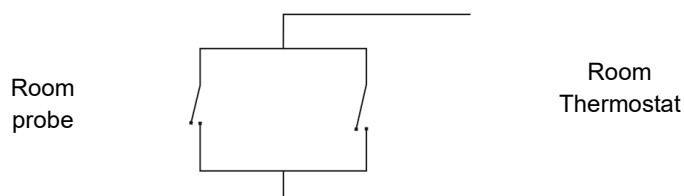

if you choose to use an external thermostat, set the room temperature value on the stove display to the minimum (7°C). At this point, stove modulation will be controlled by the external thermostat.

During the working phase, if the room temperature is lower than the set temperature and the external thermostat is active (closed contact), the stove will operate at the set power level. When the room temperature reaches the set temperature, (external thermostat contact open), the stove will go to minimum power and the display will show the message "MODULATE". This modulation has been completed only if the room temperature returns to being lower than the set temperature in the external thermostat.

## 5 USE

- All local regulations, including those relating to national and European regulations, must be observed when installing the unit. Improper installation or use of the device can result in forfeiture of the warranty.
- Do not use the unit as an incinerator or in any other way other than that for which it was designed.
- **No other fuel besides wood pellets must be used. Do not use liquid fuels.**
- **The device, especially the external surfaces, gets very hot to the touch when in use. Handle with care to avoid burns.**
- Do not make any unauthorised modifications to the device. **Only use original replacement parts recommended by the manufacturer.**
- Make sure that the room where the stove is to be installed offers sufficient ventilation (see section "1.7 External air intake vent").
- Make sure that all exhaust system joints are hermetically sealed with silicone (no cementing), are resistant to heat (250 ° C) and are not damaged.
- Periodically check (or have someone check) the cleanliness of exhaust fumes.
- **CAUTION:** keep all flammable products well away from the stove when it operating (MINIMUM: 100 cm from the front wall).
- **CAUTION:** to prevent the escape of fumes, the combustion chamber must be kept closed except during cleaning operations, to be carried out with the stove off.
- **CAUTION:** removing the safety guard inside the tank is strictly prohibited.
- **CAUTION:** in case of pellet resupply with stove on, make sure that the pellet has not ended and the flame is always present in the brazier. If the flame is extinguished a dense white smoke may form, able to cause an explosion in the combustion chamber. The explosion can be of such intensity as to break the glass of the fire door. Therefore, pay attention to never stay in front of the stove during ignition stage if the fuel releases a dense smoke. The stove is however equipped with all safety systems required to minimize the glass breakage risk.
- **CAUTION:** prevent the fuel bag to come into contact with hot surfaces.
- **CAUTION:** remove any residue of unburned pellets caused by failed ignitions before you start the stove again.
- **CAUTION:** if during the ignition phase, the stove does not start and you notice a lot of smoke in the combustion chamber, immediately turn off the stove and replace pellets in use, as these may be too high in moisture. **Forcing ignition could make your stove a hazard.**
- **CAUTION:** if during cleaning, you find traces of spongy or hard (though not ash) pellets, replace the pellets being used as this residue may come from scraps of low-quality sawdust not usable in this type of stove. Forcing ignition can cause a fire or strong production of fumes in the chimney.
- **CAUTION:** monitor proper combustion of the pellets in the brazier. **If you should detect accumulations of unburned pellets, IMMEDIATELY TURN OFF the stove and contact the service centre.**
- **CAUTION:** exercise extreme caution in the presence of children, to prevent them from standing in front of the stove.





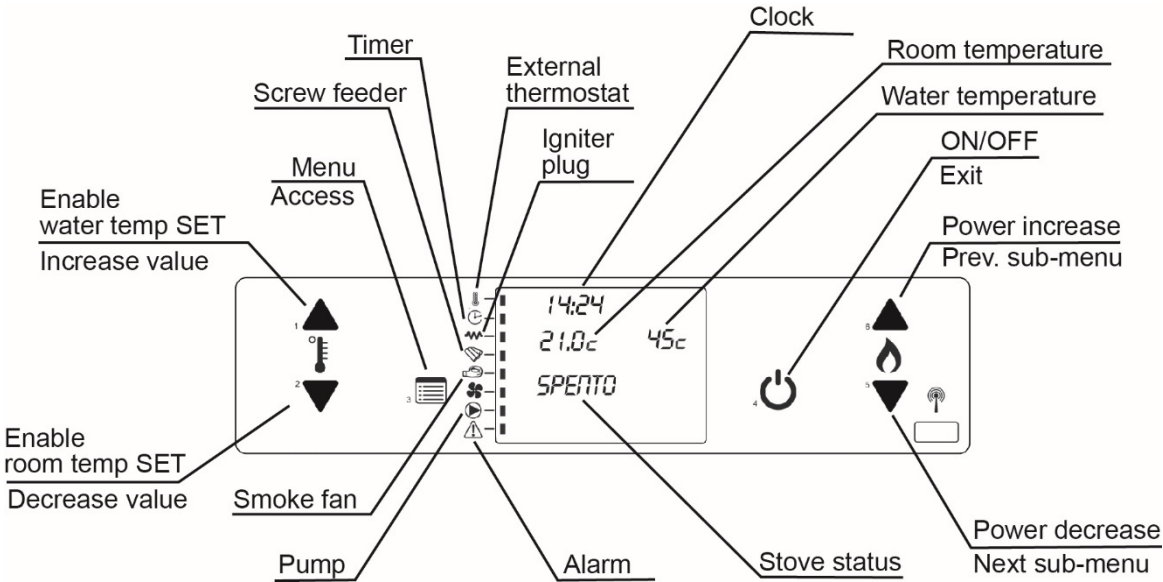

## 5.1 Console description

The console displays information about stove operating status. Access the menu to view various types of displays and adjust the settings available depending on the level of access.







Depending on the operating mode, the displays may have different meanings based on their position on the display.



Below you will see a description of the meaning of status indicators located on the left side of the display. The lighting on the display of one of the segments in the "status" area signals the activation of a corresponding device according to the list to the side.

	<i>Room thermostat LED</i>	The LED is on when it is connected to an external room thermostat and it is closed.
	<i>Chrono LED</i>	The LED switches on when the programmable thermostat is activated; meaning, if user parameter 03-01-01 enables chrono, it is different from off.
	<i>Glow plug LED</i>	The LED switches on when the glow plug is powered.
	<i>Feed screw on LED</i>	The LED switches on in the time intervals in which the pellet feed screw is in operation.
	<i>Smoke fan LED</i>	The LED switches on when the smoke fan is on.
	<i>Pump on LED</i>	The LED switches on when the pump is in operation
	<i>Alarms LED</i>	The LED switches on when there is an alarm activated on the stove.

### 5.1.1 Console button functions

	<p><b>BUTTON 4</b> ON/OFF</p>	<p>Functions:</p> <ul style="list-style-type: none"> <li>• Manual On/Off of the stove</li> <li>• Exit from a sub-menu</li> <li>• Exit from a shutdown or alarm (and passage to Off status)</li> </ul>
	<p><b>BUTTON 5</b> POWER REDUCTION</p>	<p>Functions:</p> <ul style="list-style-type: none"> <li>• Reduction in set power value</li> <li>• Passage from a sub-menu to the previous one</li> </ul>
	<p><b>BUTTON 6</b> POWER INCREASE</p>	<p>Functions:</p> <ul style="list-style-type: none"> <li>• Increase in set power value</li> <li>• Passage from a sub-menu to the next one</li> </ul>
	<p><b>BUTTON 3</b> MENU SELECTION</p>	<p>Functions:</p> <ul style="list-style-type: none"> <li>• Passage to sub-menus</li> <li>• Passage to programmable thermostat and clock programming</li> <li>• Passage to technical parameters programming.</li> </ul>
	<p><b>BUTTON 1</b> PARAMETER ADJUSTMENT (INCREASE)</p>	<p>Functions:</p> <ul style="list-style-type: none"> <li>• Passage to stove water temperature setting mode</li> <li>• In temperature setting mode increases the set value</li> <li>• In technical parameter setting mode increase the set value</li> </ul>
	<p><b>BUTTON 2</b> PARAMETER ADJUSTMENT (DECREASE)</p>	<p>Functions:</p> <ul style="list-style-type: none"> <li>• Passage to room temperature setting mode</li> <li>• In temperature setting mode reduces the set value</li> <li>• In technical parameter setting mode reduces the set value</li> <li>• In work mode activates room temperature setting</li> </ul>

### 5.2 First ignition

Before igniting the stove, you **MUST** have a qualified technician perform "FIRST IGNITION" and calibration. For this purpose, we advise you to contact personnel part of our network of authorised service centres.

**The company assumes no responsibility for malfunctions due to improper installation, failure to install, incorrect first ignition, or improper use.**

Make sure that electrical connections have been performed properly.

The first few times you light the stove, it may give off odours due to the evaporation of paint or grease. Simply ventilate the room to make the odour go away, avoiding prolonged exposure as vapours can be harmful to people or animals. Do not allow children to stay in the room during this first phase.

When the tank is loaded for the first time, the feed screw must fill up for a given period. During this time, pellets will not be distributed within the combustion chamber. To overcome this difficulty, use the command "Initial load" in menu 7 of the control panel (see further details to follow).

### 5.3 Ignition and normal operation

Before igniting the stove:

- **Check that the furnace door is locked.**
- Make sure that the pellet tank is full or contains such enough so that the stove will function for the desired amount of time.
- **Make sure that the brazier is clean**, free of ashes, combustion residue or unburned pellets (if necessary, remove the brazier and thoroughly clean it, then replace it with care in its housing).

- In the event or start-up with the programmable thermostat, make sure that the brazier is in the indicated conditions after last use.

When the stove is connected to the electrical system but not in work mode, the display will show the message "OFF".

### 5.3.1 Stove start-up

To start up the stove, hold and press the start button (4) for 2 seconds

If you start the stove during the final cleaning phase, the display may show the message "WAIT COOLING." In this case, wait for a minute before retrying ignition

#### First phase - Preparation

The message "START" will appear on the display. In this phase, which lasts for about one minute, the pellet glow plug activates and combustion chamber forced ventilation starts along with activation of the fume extraction fan.

#### Second phase – Ignition

After the preparation phase, the display will show the message "LOAD PELLETS" and ignition will begin. This second phase is divided in two parts: pre-loading and actual ignition. First, the pellet feed screw is activated (the Feed screw ON LED  lights up) for a variable time interval, depending on the model, and pellets begin to fall inside the brazier.

**Remember that the brazier must be perfectly clean at this beginning of this stage.**

Once this "pre-loading" phase is completed, the pellet feed screw will stop for a variable amount of time depending on the model (from two to three minutes). After this waiting phase, the pellet feed screw will start to switch on at regular intervals and pellets will then continue falling inside the stove brazier, while the glow plug and then fume exhaust fan will both remain activated.

As soon as the pellets cover the glow plug hole, you will notice first a reddening and then the onset of a small flame in the brazier.

If pellets continue to fill the brazier without this happening, manually stop the ignition process without waiting for the stove to set off an alarm: "AL 5 NO START".

This second phase is completed when the stove detects successful triggering of the combustion process, or rather after 4-5 minutes from the triggering of the first flame.

If combustion is not detected within a given amount of time, the no start-up alarm will be activated ("AL 5 NO START" message).

#### Third phase - Stabilization

Once combustion triggering has been detected, the third phase will start and the display will show the message "FIRE PRESENT". Pellet feeding is reduced and ventilation increased in order to allow a stabilisation of the flame and disposal of excess pellets accumulated in the brazier during the ignition phase. This phase lasts about 5 minutes.

Once the stabilisation phase has been completed ("FIRE PRESENT"), the stove passes to the normal working phase.

### 5.3.2 No start-up

As said, if the onset of combustion is not detected, the no start-up alarm will be set off. The display will show the message "AL 5 NO START" and an acoustic signal will be heard at regular intervals (if the buzzer function is active in Menu 6).

To disable the alarm, hold and press the ON-OFF (4) (about 2 secondi). The acoustic alarm will stop and the stove will return to "FINAL CLEANING" status and then to "OFF."

Before starting another ignition cycle verify the cause of the alarm, specifically

- **Verify that the pellet tank is not empty.**
- **Verify that the brazier is in the right position.**
- Remove the unburned pellets from the brazier (**VERY IMPORTANT**).

**CAUTION:** An excessive quantity of pellets in the brazier, a humid pellet or dirty brazier make the ignition stage difficult. If these critical conditions are present a dense white smoke capable of causing

an explosion in the combustion chamber may form. The explosion can be of such intensity as to break the glass of the fire door. Therefore, pay attention to never stay in front of the stove during ignition stage if the fuel releases a dense smoke.

**The stove is however equipped with all safety systems required to minimise this risk.**

**If the device does not ignite regularly, the main cause may be insufficient maintenance or poor pellet quality.**

### 5.3.3 Normal operation

As soon as the ignition phase is over, the stove will go into normal working mode.

During this phase, the display will show the following information:

- The first line shows the time.
- The second line shows the room temperature while the line on the right shows water temperature in the stove
- The third line shows the message "WORK". while the line on the right shows set power.
- The fourth line usually shows the instantaneous working power. The message "MODULATE" also is shown when room temperature or water temperature reaches the set temperature (see corresponding paragraph).

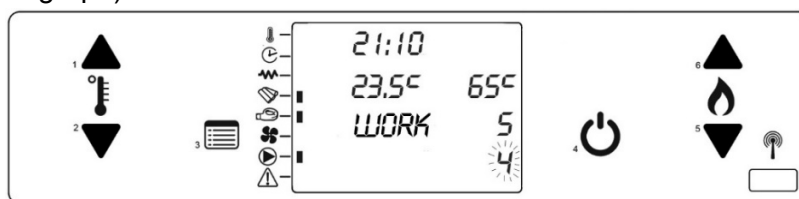

During normal working mode, the following operations can be performed:

- Stove power setting, choosing from one of the five available levels. Power setting is carried out via BUTTONS "5" and "6".
- Desired room temperature setting, choosing an interval from 7°C to 40°C. Set the temperature with button "1" to increase and "2" to decrease.
- Desired stove temperature setting, choosing an interval from 30°C to 80°C. Press "1" once and then set the temperature with button "1" to increase and "2" to decrease.
- View water circuit pressure. Press and hold button 5.

Periodic brazier cleaning is also active during working mode. Brazier cleaning mode is activated at regular intervals of about one hour. In this way, the smoke extractor works at maximum power while pellet feeding is reduced to minimum. This operation is necessary for eliminating ash deposits inside the brazier and for ensuring proper aeration and combustion. During brazier cleaning, the display will show the message "BRAZIER CLEANING". **If you notice excessive accumulation of pellets in the brazier during normal operation, turn off the stove immediately and contact a service centre. Forcing could make your stove a hazard.**

### 5.3.4 Modulation based on room temperature

The stove is equipped with an internal temperature sensor that allows it to modulate its power according to the desired room temperature.

For correct environment sensor operation, verify that the room sensor positioned in the rear of the stove under the outlet (*Fig 15*) is away from the fume exhaust pipe and is not in contact with objects or walls. Press button "2" to set room temperature. The message " SET ROOM TEMP" will appear on the bottom of the display, while the upper part will show the set temperature. To modify this value, use buttons "1" and "2" until you reach desired temperature (7°C to 40°C).

If the room temperature reaches the set temperature, the stove goes into minimum power and the last line of the display shows "MODULATE." This modulation has been completed only if the room temperature returns to being lower than the set temperature. In this case, the stove will return to the power set by the user and the display will show the message "MODULATE" and standard working indications will return

### 5.3.5 Modulation based on stove water temperature

The stove is equipped with water temperature sensor that allows it to modulate its power according to the desired temperature.

To set water temperature, press button "1". Press button "1" once and the bottom of the display will show the message " SET WATER TEMP", while the upper part of the display will show the set water temperature. To modify this value, use buttons "1" and "2" until you reach desired temperature (30°C to 80°C). **We recommend setting water temperature in the stove between 60° C and 70° C.**

During the working phase, if the water temperature in the stove is much lower than the set value, the stove operates at the maximum power level set.

However, when the water temperature approaches the set value (difference of less than 3° C), the stove heater gradually decrements the power level. The last line of the display shows a flashing number that indicates the power level at which the stove is working at that moment. A decrease in water temperature will correspond to an increase of the power level until it returns to the maximum power value set initially.

**We recommend always setting hydro stove power to its maximum value "5".**

If, despite reducing power, water temperature continues to rise and reaches the set temperature, the bottom line of the display will show "MODULATE." If, despite modulation, the water temperature tends to rise further (for example when zone valves are closed), it may be best to activate stand-by mode (see section 6.5).

### 5.3.6 Circulator

This stove has a circulator and an expansion tank for direct connection of the system stove to radiators. The circulator starts as soon as water reaches a temperature of 55° C (value that must not be lowered to prevent formation of condensation in the stove) and works according to water temperature.

### 5.3.7 Brazier cleaning

During normal operation in work mode, "BRAZIER CLEANING" is activated at set intervals. During this time, the display will show the message "BRAZIER CLEANING", stove ventilation increases and the flame lowers in the brazier. This operation is necessary to decrease the likelihood of ash accumulation of ash inside the brazier.

**If you notice an excessive accumulation of pellets in the brazier (over half the level of the brazier itself), immediately switch off the stove and clean the brazier. Promptly contact a service centre.**

### 5.3.8 Shutdown

To turn off the stove, hold button 4 for a few seconds.

Once the shutdown signal has been received, the display will show a "FINAL CLEANING" message and the fume exhaust fan will continue to run at full speed for a minimum time of about 10 minutes to ensure complete cooling of the stove. The hot air fan will also continue to run until the stove cools down.

**CAUTION: Never disconnect the power supply at this stage, as this may create problems for the stove and compromise the subsequent phases of ignition.**

### 5.3.9 Interruption of power supply

In the event of a brief interruption in the power supply (under 10 seconds), the stove will automatically re-start without any alarms.

If power is lost for a longer time and the stove was in work mode, an "AL 1 - BLACK OUT" alarm will be generated. The stove will therefore not start back up automatically, but first the alarm will need to be manually removed



### 5.3.10 Remote control

The control panel of the stove has been set up to receive all the functions also via the supplied remote control. (Battery type CR2025 3V)

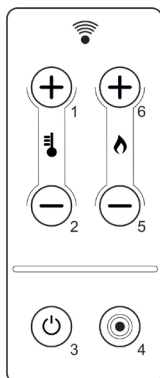

<b>BUTTON 1</b>	<ul style="list-style-type: none"> <li>• Switching to stove water temperature setting mode</li> <li>• In temperature setting mode, it increases the set value</li> <li>• In technical parameter setting mode, it increases the set value</li> <li>• In work mode it activates water setting in the boiler</li> </ul>
<b>BUTTON 2</b>	<ul style="list-style-type: none"> <li>• Switching to room temperature setting mode</li> <li>• In temperature setting mode, it reduces the set value.</li> <li>• In technical parameter setting mode, it reduces the set value.</li> <li>• In work mode, it activates room temperature setting</li> </ul>
<b>BUTTON 3</b>	<ul style="list-style-type: none"> <li>• Switching to sub-menus</li> <li>• Switching to programmable thermostat and clock programming</li> <li>• Switching to technical parameters programming.</li> </ul>
<b>BUTTON 4</b>	<ul style="list-style-type: none"> <li>• Manual stove start-up and shut-down</li> <li>• Exit from a sub-menu</li> <li>• Exit from shut-down or alarm (and passage to off status)</li> </ul>
<b>BUTTON 5</b>	<ul style="list-style-type: none"> <li>• Reduction in set power value</li> <li>• Switching from a sub-menu to the previous one</li> </ul>
<b>BUTTON 6</b>	<ul style="list-style-type: none"> <li>• Increase in set power value</li> <li>• Switching from a sub-menu to the next one</li> </ul>

## 6 MENU

Press button "3" (MENU) to access the menu.

The menu is divided into different items and levels that allow you to access board settings and programming.

Menu items that allow you to access technical programming are protected by an access key.

### User menu

The following table briefly describes the structure of the menu, focusing only on selections available to the user in this section.

To operate from the menu, follow the guidelines below:

- Use button "3" to enter into the selected menu or sub-menu (you go down a level).
- Use button "4" to do the reverse and exit the menu or sub-menu in which you are located (you go up a level).
- Use buttons "1" and "2" to modify a parameter value (temperature, time, etc.).
- Use buttons "5" and "6" to move horizontally between different menus or sub-menus or parameters.

### 6.1 Menu 01 "WATER PRESSURE"

This item allows you to bypass pressure control when the heating stove or boiler is connected to an open vessel. Use buttons "1" and "2" to select "on/off".

### 6.2 Menu 02 "CLOCK SET"

You can set the current time and date in this menu. The board is equipped with a lithium battery that allows internal clock autonomy over 3/5 years.

Enter into MENU and set, in order:

01	Day of the week	(Monday ... Sunday)
02	Hour	(0... 23)
03	Minutes	(0... 59)
04	Day of the month	(1...31)
05	Month of the Year	(1...12)
06	Current Year	(2000... 2099)

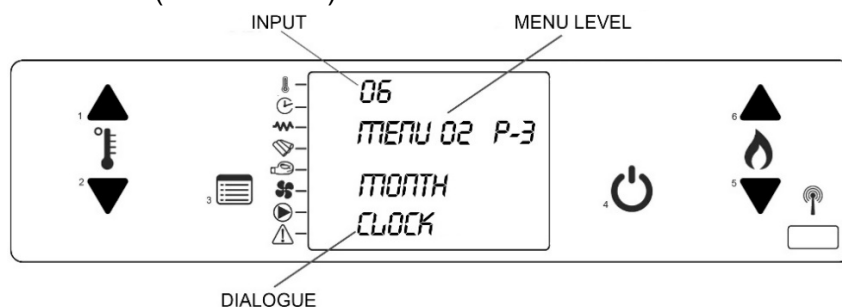

### 6.3 Menu 03 "CHRONO SET"

Use this menu to enable and programme start-ups and shutdowns. There are eight different possibilities divided into three groups:

- **Daily programme:** 2 start-ups and shutdowns valid each day.
- **Weekly programme:** 4 start-ups and shutdowns, for which you can decide which days of the week they must be active.
- **Weekend program:** 2 start-ups and shutdowns valid only for Saturday and Sunday.

Below is the diagram of the various Menu levels. Access the menu by pressing "3", return to the previous menu by pressing "4", scroll through the menu by pressing "5" and "6" and change the value by using keys "1" and "2"

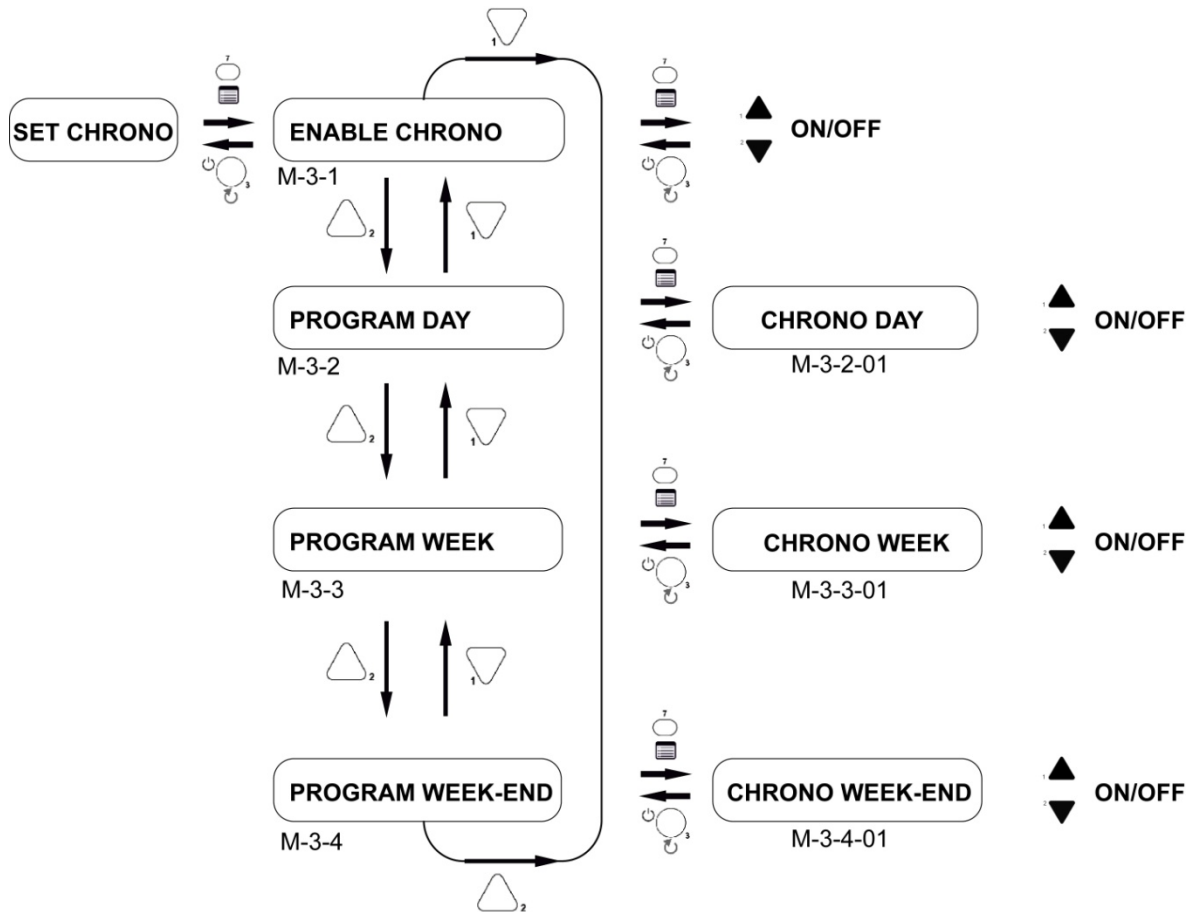

### 6.3.1 Menu 3-1 “ENABLE CHRONO”

Allows you to enable and disable all programmable thermostat functions.  
If the value is "off", all set programmes are disabled

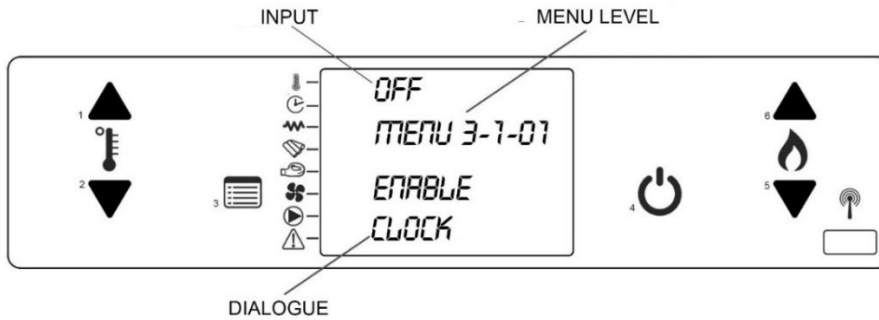

### 6.3.2 Menu 3-2 “DAILY PROGRAMME”

Allows you to enable, disable and set all programmable thermostat functions.

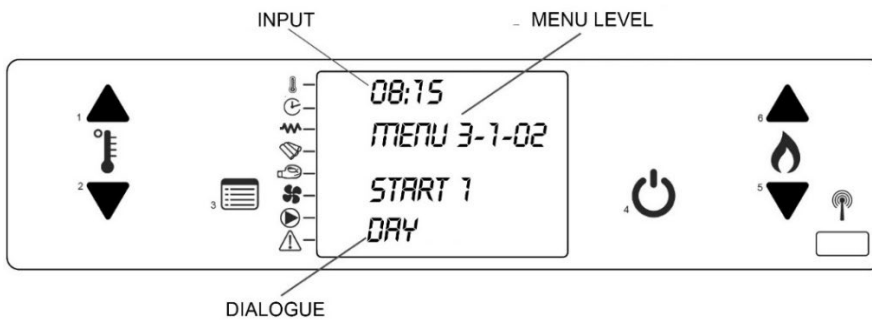

After having set the first parameter (M-3-2-01) "DAILY CHRONO" to "On", you can set two start-ups and two shutdowns. For each parameter, you can either set the value "Off", if you do not wish to activate, or the time of start-up or shutdown.

<i>Menu level</i>	<i>Selection</i>	<i>Meaning</i>	<i>Possible values</i>
M 3-2-02	START 1	Activation Time	00:00-23:50 -OFF
M 3-2-03	STOP 1	Disable time	00:00-23:50 -OFF
M 3-2-04	START 2	Activation time	00:00-23:50 -OFF
M 3-2-05	STOP 2	Disable time	00:00-23:50 -OFF

### 6.3.3 Menu3-3 "WEEKLY PROG"

The weekly programming group includes 4 start-ups and 4 shutdowns. For each on-off pair, you can decide which day of the week to activate the corresponding pair controls.

With the first parameter, M-3-3-01 "WEEKLY CHRONO", you can enable or disable all weekly programmable settings

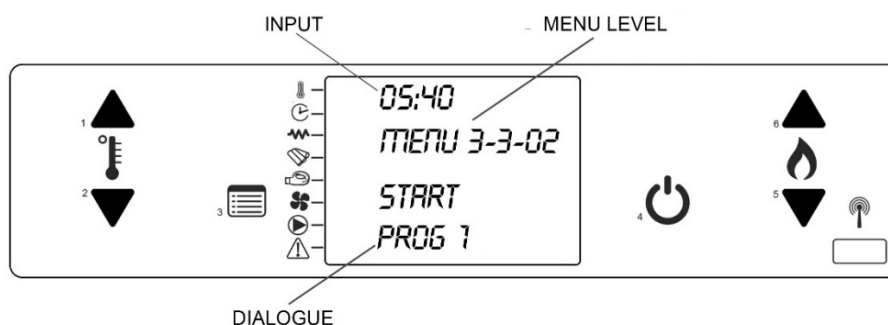

After having set the first parameter (M-3-2-01) "WEEKLY CHRONO" to "on", you can set 4 start-ups and 4 shutdowns. For each parameter, you can either set the value "off", if you do not wish to activate, or the time of start-up or shutdown. After each pair of on and off times, there are 7 parameters corresponding to the 7 days of the week. Each of these parameters can be set to "On" or "Off" based on which programming you wish to activate corresponding to that day of the week. (See following tables).

<b>PROGRAMME 1</b>			
<i>Menu level</i>	<i>Selection</i>	<i>Meaning</i>	<i>Possible values</i>
M 3-3-02	START PROG 1	On Time	00:00-23:50 -OFF
M 3-3-03	STOP PROG 1	Off Time	00:00-23:50 -OFF
M 3-3-04	MONDAY PROG 1	Reference day	on/off
M 3-3-05	TUESDAY PROG 1		on/off
M 3-3-06	WEDNES-PROG 1		on/off
M 3-3-07	THURSDAY PROG 1		on/off
M 3-3-08	FRIDAY PROG 1		on/off
M 3-3-09	SATURDAY PROG 1		on/off
M 3-3-10	SUNDAY PROG 1		on/off

<b>PROGRAMME 2</b>			
<i>Menu level</i>	<i>Selection</i>	<i>Meaning</i>	<i>Possible values</i>
M 3-3-11	START PROG 2	On Time	00:00-23:50 -OFF
M 3-3-12	STOP PROG 2	Off Time	00:00-23:50 -OFF
M 3-3-13	MONDAY PROG 2	Reference day	on/off
M 3-3-14	TUESDAY PROG 2		on/off
M 3-3-15	WEDNES-PROG 2		on/off
M 3-3-16	THURSDAY PROG 2		on/off
M 3-3-17	FRIDAY PROG 2		on/off
M 3-3-18	SATURDAY PROG 2		on/off
M 3-3-19	SUNDAY PROG 2		on/off

<b>PROGRAMME 3</b>			
<i>Menu level</i>	<i>Selection</i>	<i>Meaning</i>	<i>Possible values</i>
M 3-3-20	START PROG 3	On Time	00:00-23:50 -OFF
M 3-3-21	STOP PROG 3	Off Time	00:00-23:50 -OFF
M 3-3-22	MONDAY PROG 3	Reference day	on/off
M 3-3-23	TUESDAY PROG 3		on/off
M 3-3-24	WEDNES-PROG 3		on/off
M 3-3-25	THURSDAY PROG 3		on/off
M 3-3-26	FRIDAY PROG 3		on/off
M 3-3-27	SATURDAY PROG 3		on/off
M 3-3-28	SUNDAY PROG 3		on/off

<b>PROGRAMME 4</b>			
<i>Menu level</i>	<i>Selection</i>	<i>Meaning</i>	<i>Possible values</i>
M 3-3-29	START PROG 4	On Time	00:00-23:50 -OFF
M 3-3-30	STOP PROG 4	Off Time	00:00-23:50 -OFF
M 3-3-31	MONDAY PROG 4	Reference day	on/off
M 3-3-32	TUESDAY PROG 4		on/off
M 3-3-33	WEDNES-PROG 4		on/off
M 3-3-34	THURSDAY PROG 4		on/off
M 3-3-35	FRIDAY PROG 4		on/off
M 3-3-36	SATURDAY PROG 4		on/off
M 3-3-37	SUNDAY PROG 4		on/off

#### **6.3.4 Menu 3-4 “WEEK-END PROG”**

Allows you to enable, disable and set programmable thermostat functions for the weekend (Saturday and Sunday). As per daily programmes, we have an enabling parameter and 2 pairs of start-up and shutdown times. Programming will be active as stated only on Saturday and Sunday.

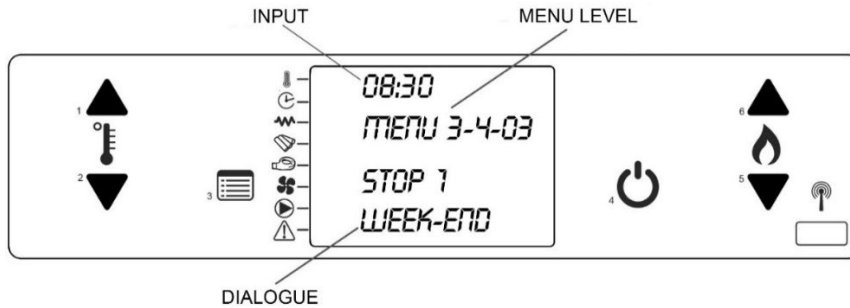

**TIP:** to avoid confusion and unwanted start-up and shutdown, activate only one programme at a time if you do not know exactly what your desired programming is. Disable the daily programme if you want to use weekly programming. Always disable the weekend programme if you are using weekly programmes. Activate the weekend programme only after having disabled weekly programming.

#### 6.4 Menu 04 “CHOOSE LANGUAGE”

Allows you to select the dialogue language among those available.

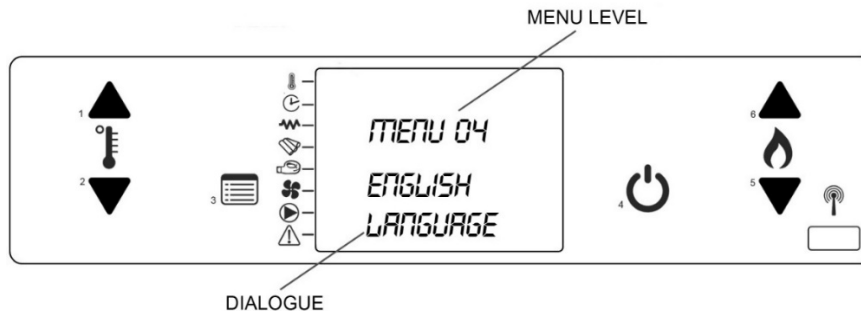

#### 6.5 Menu 05 “STAND-BY MODE”

This menu allows you to activate or deactivate "STAND-BY". (Default setting is "OFF")

Stand-by mode indicates a condition in which the stove shuts off but where it automatically re-ignites as soon as the room temperature fall below the set value and the flue gas temperature drops below its threshold (stove is cold).

Once the stand-by Menu is set to a value between 1'-120', if the room temperature exceeds a certain amount, set values (2°C), an alternating message "MODULATE / OK STD BY" appears on the screen. At this point, after a pre-set time (default 10 minutes), if temperatures do not return under the set values, the stove shuts off and goes into stand-by mode.

During shutdown, the display shows the message "WAIT COOLING." This display message remains until re-lighting conditions are verified.

When the stove is controlled by an external thermostat, by activating the stand-by mode, it is possible to control ignition and shutdown directly from the thermostat.

#### 6.6 Menu 06 “BUZZER MODE”

When "off," acoustic signal disabled in the event of an alarm. When "on," sets off a buzzer when an alarm is activated.

#### 6.7 Menu 07 “INITIAL LOAD”

When the display shows the message "OFF," allows you to preload pellets for a time equal to 90 sec. Start by pressing button "1" and stop if desired by pressing button "4." Once preloading is completed, remove the loaded pellets from the brazier.

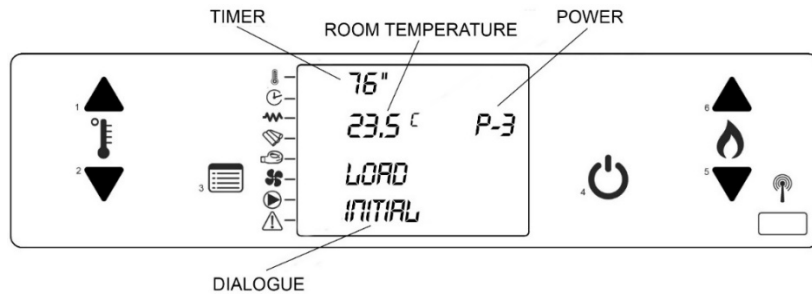

### 6.8 Menu 08 “STOVE STATUS”

The stove status menu shows the current state of the stove, showing some sensor values and other variables inside the stove. Four pages displayed in succession are available.

This menu is for qualified service personnel use.

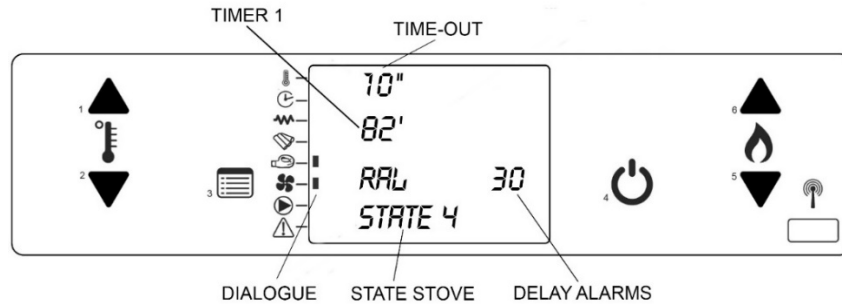

### 6.9 Menu 09 “TECHNICAL CALIBRATION”

This menu is protected by an access key and is intended for qualified service personnel.

### 6.10 Menu 10 “PELLET TYPE”

This menu allows you to simultaneously increase or decrease all pellet lowering parameters (quantity of pellets and brazier loading). The set default value is 00. Press keys (1) and (2) to modify said value from -9 to +9. For each unit, pellet load times are increased or decreased by 2.5 %.

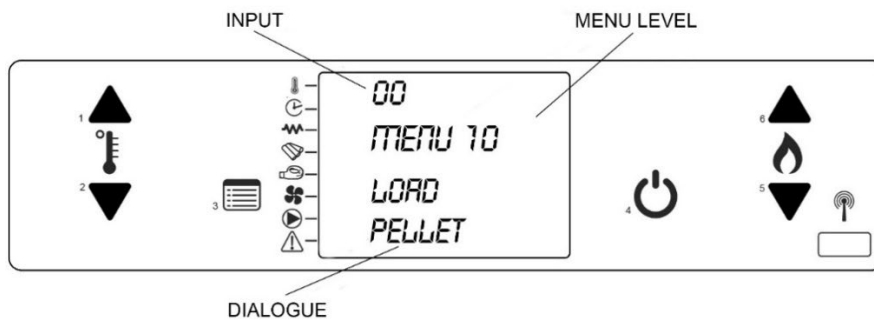

### 6.11 Menu 11 “FIREPLACE TYPE”

This menu allows users to simultaneously increase or decrease all smoke fan parameters (draft). The set default value is 00. Press keys (1) and (2) to modify said value from -9 to +9. For each unit, smoke motor revs are increased or decreased by 2.5%.

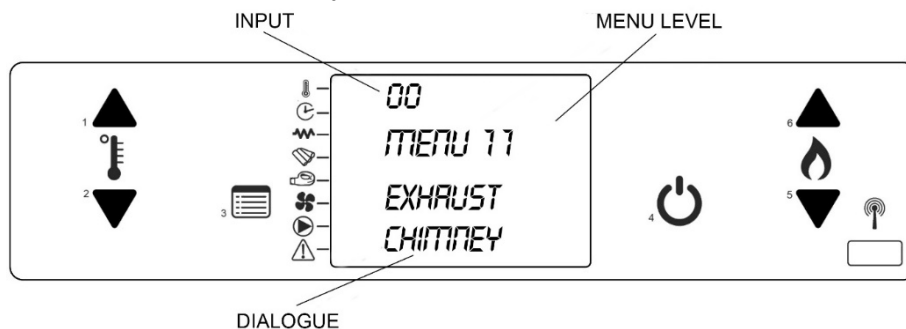

### 6.12 Menu 12 “FAN”

This menu allows you to activate or disable fan in HYDROVENTILATED models.

## 7 SAFETY AND ALARMS

### 7.1 Safety devices

**CAUTION:** During operation, some parts of the stove (door, handle, ceramic parts) can reach very high temperatures.

Remember to keep at the previously mentioned safe distance.

Be careful, **use caution** and always follow the instructions.

If during operations any part of the stove or the exhaust pipe leak smoke, immediately turn off the stove without removing the power supply and ventilate the room. Then, once cooled down, verify the reason for the leak and, if necessary, call service personnel.

The stove is equipped with several devices which intervene in order to ensure safe operation.

**CAUTION: safety devices are designed to eliminate any risk of damage to persons, animals or things, and tampering with or servicing by unauthorised personnel could compromise their safety.**

**Safety devices on the stove include the following:**

#### 7.1.1 Fume exhaust pressure sensor

This sensor is connected to the fume exhaust pressure duct. It controls internal pressure to the duct, monitoring any occlusion of the chimney flue and allowing use of the stove in total safety.

##### **When it activates**

If proper operation conditions in the fume exhaust duct are altered (improper installation, the presence of obstacles or impediments in the exhaust tube, negligent maintenance, adverse weather conditions such as persistent wind, etc.), the pressure sensor (pressure gauge) stops electrical power supply to the pellet feed screw, thus blocking pellet feeding to the brazier and sending an alarm signal to the board.

The alarm can also be caused by clogging in the stove, by improper combustion or lack of annual stove cleaning.

When the alarm goes off, the display shows the message **"AL 8 – LOW PRESSURE"**.

#### 7.1.2 Temperature sensor

The stove is equipped with a manual reset bulb thermostat whose function is to preserve the stove, pellet tank and, consequently, the whole structure from excessive temperature changes.

##### **When it activates**

If the pellet loading tube reaches the threshold of 85°C the thermostat interrupts electrical power to the feed screw, thus blocking pellet feeding to the brazier and sending an alarm signal to the board.

The display will show the message **"AL 7 – Thermal safety"**.

#### 7.1.3 Smoke temperature sensor

The smoke sensor is directly connected to the circuit board and keeps operating temperature of exhaust fumes from the stove under constant control, allowing safe use of the stove.

##### **How it works**

If fume temperature exceeds the first pre-set temperature limit, the board passes into modulation mode. The display will show the message **"MODULATE / MAX SMOKE"**. At the same time if, despite passage to modulation, the fume temperature continues to increase and exceeds the second pre-set safety limit, the stove will pass into alarm mode. Pellet flow is interrupted and fume exhaust speed is set to maximum.

The display will show the message **"AL 3 – SMOKE TEMP"**.

**The stove constantly controls smoke sensor functioning**, If the sensor is momentarily and/or accidentally removed from its housing, or the connector is not correctly positioned on the circuit board or the sensor fails for any reason. The fault is signalled via display message **AL 2 – "SMOKE SENSOR"**



### 7.1.4 Water temperature sensor

The water sensor is directly connected to the electronic board and keeps operating water temperature in the boiler under constant control, allowing safe use of the boiler.

#### How it works

If water temperature exceeds the first pre-set temperature limit, the board passes into modulation mode. The display will show the message “modulate”. At the same time if, despite passage to modulation, the water temperature continues to increase and exceeds the second pre-set safety limit (about 90 °C), the boiler will pass into alarm mode.

The display will show the message **AL A – WATER TEMP**”.

**The boiler constantly checks water probe operation**, if the sensor is momentarily and/or accidentally removed from its housing, or the connector is not correctly positioned on the electronic board or the sensor fails for any reason. The fault is signalled via display message **AL 9 – “WATER SENSOR”**.

### 7.1.5 Water pressure switch

The water pressure switch is directly connected to the electronic board and keeps operating water temperature in the boiler under constant control, allowing safe use of the boiler.

#### How it works

If water pressure drops below 0.5 bar or over 2.5 bar, the boiler passes into alarm mode and **AL b – “WATER PRESS”** appears on the display.

## 7.2 Alarms

In the event that an operating anomaly occurs, the board intervenes and signals the irregularities, operating in different modes depending on the type of alarm. The following alarms can occur:

Cause of alarm	Display message
No power	<i>AL1 BLACK-OUT</i>
Smoke temperature sensor	<i>AL2 SMOKE SENSOR</i>
Smoke overtemperature	<i>AL3 SMOKE TEMP</i>
Smoke fan fault	<i>AL4 EXTRACT FAULT</i>
No start-up	<i>AL5 NO START</i>
Shutdown during work mode	<i>AL6 NO PELLETT</i>
General safety thermostat	<i>AL7 THERMAL SAFETY</i>
Safety pressure switch	<i>AL8 LOW PRESSURE</i>
No or low water sensor	<i>AL9 WATER SENSOR</i>
Water overtemperature	<i>ALa WATER TEMP</i>
Water pressure outside allowed values	<i>ALb WATER PRESS</i>

### **ALL ALARM CONDITIONS CAUSE IMMEDIATE STOVE SHUTDOWN**

**To exit from an alarm condition, always press button "4" until the message "FINAL CLEANING" appears.**

You will also need to take additional steps, depending on the type of alarm generated

If you do not exit from the alarm condition within a given time (a few hours), the alarm will be sent into stove memory and the display will show the message "ALARM MEMORY". To exit from this condition, press button "4" as per above.

### **AL 1 - Black-out**

This alarm is activated when the stove is disconnected from the mains.

#### **What to do**

Put the stove in stand-by by pressing the off button for a few seconds.

### **AL 2 – Smoke sensor**

This alarm signals breakage of the smoke sensor

#### **What to do**

- Put the stove in stand-by by pressing the off button for a few seconds (4).
- Wait and make sure that the combustion of pellets left in the brazier has been completed.
- If necessary, call a support centre to replace the sensor

### **AL 3 – Smoke temp**

This alarm signals excessive smoke exhaust temperature (see safety devices)

#### **What to do**

- Put the stove in Off state by pressing the off button for a few seconds (4).
- Wait and make sure that the combustion of pellets left in the brazier has been completed.
- After having cleaned the brazier, restart the stove by pressing the key (4).
- If necessary, call a support centre to replace the sensor

### **AL 4 – Extract fault**

This alarm indicates a failure to read the revs of the smoke expulsion motor by the control board. It may have been activated due to motor fault or due to a lack of connection between the rev reader (encoder) in the motor and the board.

#### **What to do**

Put the stove in Off state by pressing the off button for a few seconds. Try switching the stove back on.

**Contact your support centre if the problem persists.**

### **AL 5 - No start**

This alarm signals an ignition failure. This alarm is activated when, during the start-up phase, a maximum waiting time (about 20 minutes) is exceeded without the machine switching on successfully. (See 5.3.1)

### **AL 6 - No pellet**

This alarm indicates a flame failure in the brazier during normal stove operation. The main causes are: no pellets in the tank or blocking of the pellet feed screw.

#### **What to do**

- Put the stove in stand-by by pressing the off button for a few seconds.
- Empty the brazier of all unburned accumulated pellets.
- In the event of pellet exhaustion in the tank, refuel the stove and ignite it again. Do not insert pellets until the stove has cooled completely. **Pellet refilling must always be performed with the stove off or with the stove operating with the flame present.**
- In the case of a pellet feed screw block, empty the tank and remove any foreign bodies present in the feed screw. Then refill with pellets and start the stove back up
- **In the case of repeated feed screw blocks, call a support centre**

### **AL 7 – Thermal safety**

This alarm is activated by intervention of the safety thermostat installed inside the stove

#### **What to do**

- Put the stove in stand-by by pressing the off button for a few seconds.
- Wait and make sure that the combustion of pellets left in the brazier has been completed.

- **Reset the safety thermostat** located on the rear of the stove under the outlet (*see fig. 15*).

Before resetting, make sure that the stove is **off and completely cooled down**, then proceed as follows:

- Unscrew the cap located on the rear of the stove (*see figure 15*);
- Press the red button applying a slight pressure;
- Re-screw the cap in its housing;
- **After having cleaned the brazier**, re-start the stove by pressing button 4;

### **AL 8 – No vacuum**

This alarm is activated by intervention of the vacuum sensor (vacuum gauge)

#### **What to do**

- Put the stove in stand-by by pressing the off button for a few seconds.
- Wait and make sure that the combustion of pellets left in the brazier has been completed.
- Wait for the stove to cool down, then verify and remove the causes that triggered the safety device. Finally, after having cleaned the brazier, re-start the stove by pressing the ON/OFF button (4).

**In the event of a repeated alarm, call the support centre.**

### **AL 9 - Water sensor**

This alarm is activated by the breakage or disconnection of the water probe of the boiler.

#### **What to do**

- Put the boiler in stand-by by pressing the off button for a few seconds (4).
- Wait and make sure that the combustion of pellets left in the brazier has been completed.
- If necessary, call a support centre to replace the sensor

### **AL A -Water temp**

This alarm is activated by the over-temperature of the water in the boiler.

#### **What to do**

- Put the boiler in stand-by by pressing the off button for a few seconds.
- Wait and make sure that the combustion of pellets left in the brazier has been completed.
- Verify and remove the causes which caused the safety devices to go off.
- After having cleaned the brazier, re-start the boiler by pressing button (4);

### **AL b - Water press**

This alarm is activated by the incorrect pressure of the water in the boiler.

#### **What to do**

- Put the boiler in stand-by by pressing the off button for a few seconds.
- Wait and make sure that the combustion of pellets left in the brazier has been completed.
- Verify and remove the causes which caused the safety devices to go off.
- **Check and fix pressure level in the boiler circuit.**
- After having cleaned the brazier, re-start the boiler by pressing button 4.

### **Service**

This warning appears on the display after a certain number of hours of operation.

It does not block the operation of the stove but warns that it is necessary to contact a Support center to have the extraordinary maintenance operations carried out on the product. (*See paragraph 8.13*)

## 8 WARNING AND MAINTENANCE

All maintenance operations (cleaning, replacements, etc.) should be carried out when the fire is out and the stove is cold. In addition, do not use any abrasive substances.

**CAUTION: FAILURE TO CLEAN AFFECTS SAFETY**

### 8.1 Opening the door

The door must remain closed during operation. The door should be opened only with the stove off and cooled down to perform maintenance and routine cleaning.

### 8.2 Ash drawer cleaning

Check the ash drawer every two days to see if it needs emptying. The ash collection compartment must be emptied regularly so as to impede combustion residue from arriving at the brazier support. Ashes must be placed in a metal container with a sealed lid. Until ashes are completely out, the sealed container should be placed on a non-combustible base or on the floor, or well away from combustible materials.

**CAUTION: ashes keep embers on for a long time!!!**

### 8.3 Brazier cleaning

When the flame becomes a red colour or is weak accompanied by black smoke, it may mean that there are ash deposits or incrustations which are not allowing correct stove operation and which must be removed.

**Every two days, remove the brazier by simply lifting it from its housing, then clean it of ash and any incrustations which could have formed, with particular attention to freeing clogged holes using a pointed tool.**

This operation is necessary in particular the first few ignitions, especially when using different quality pellets. The timing of this operation is determined by the frequency of use and the choice of fuel. It is advisable to also check the brazier support, emptying it of any ashes.

**CAUTION:** before igniting the stove, check that the brazier is pushed back toward the deflector and that the glow plug tube is inserted in the corresponding brazier hole.

### 8.4 Combustion chamber cleaning

Clean the combustion chamber weekly, removing ashes accumulated in the chamber using a vacuum cleaner.

Note Use a vacuum cleaner designed for the suction of ashes for this type of cleaning.

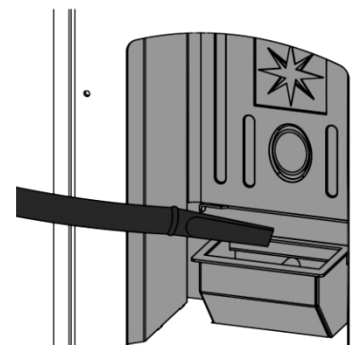
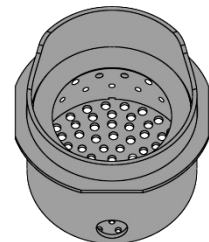
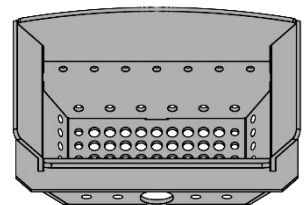
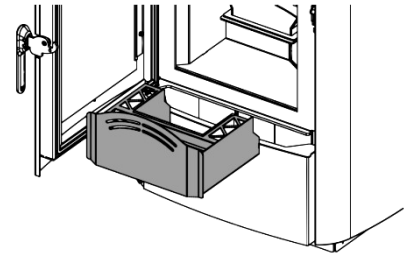

## 8.5 Smoke chamber cleaning

Generally, clean the smoke chamber once a year (preferably at the beginning of the season) for best stove operation. The frequency of this operation depends on the type of pellet used and the frequency of use.

**Contact a Technical Assistance Centre for this type of cleaning.**

## 8.6 Exhaust system cleaning

Until you are reasonably experienced regarding operating conditions, it is advisable to perform this service at least monthly. Remove the T-fitting cap and proceed with duct cleaning.

If necessary, at least the first few times, request assistance from a qualified technician.

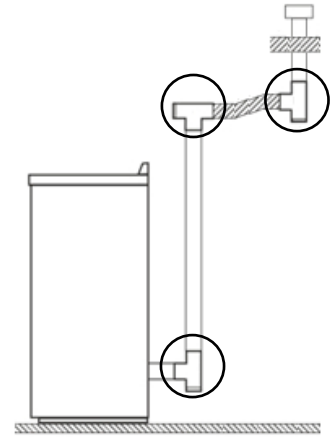

## 8.7 Cleaning metal and ceramic parts

Use a soft cloth moistened with water to clean metal stove parts.

**Never clean metal or ceramic parts with alcohol, thinners, petrol, ketones or other degreasers.** Use of these substances frees the company from all liability. Discolouration of metal parts can be the result of improper use of the stove

## 8.8 Cleaning glass

**Door glass must be clean cold** with ammonia-based and non-corrosive degreasers as a diluent. Prevent corrosive substances from coming into contact with the paint on the stove as these can cause damage. If glass is hot, before proceeding with cleaning, keep the door open as long as necessary until it cools down. Do not use any material that can scratch or damage the glass.

## 8.9 Broken glass

The stove is equipped with 5 mm thick ceramic glass that is resistant to a thermal shock of 750°C. This glass can break only due to a strong impact or misuse. Do not slam the door or hit the glass. In case of breakage, replace with an original replacement part only.

**Contact a Technical Assistance Centre to replace.**

## 8.10 Replacing the remote-control battery

Replace the old battery with a new *CR2025 eV* battery, taking care not to invert polarity. Then close the remote control and dispose of the used battery in compliance with regulations. The installed battery must be the type specified above. Failure to comply with these instructions may create an explosion hazard.

## 8.11 Cleaning fans

**CAUTION: all cleaning and/or maintenance operations must be performed with the POWER OFF.** The stove is equipped with fans (room and fumes) located at the lower rear of the stove. Any deposits of dust or ash on fan blades lead to an imbalance which causes noise during operation. Fans must therefore be cleaned at least once annually.

**As this operation involves the removal of some stove parts, have the fan cleaned by Technical Assistance Centre or qualified personnel only.**

## **8.12 Stove inactivity**

At the end of the season, perform the following operations:

- Remove all pellets from the tank and from the feed screw.
- Thoroughly clean the brazier, the support brazier, the combustion chamber and the ash drawer.
- Thoroughly clean the smoke exhaust system: contact a professional chimney sweep for this purpose.
- Clean all dust, spider webs, etc. from the area behind the panels of the inner cladding once a year.
- Clean fans thoroughly.
- Disconnect the power cable.
- Leave the fire door ajar to prevent the humidity entering from the smoke duct from oxidizing the internal walls.

## **8.13 Routine and special maintenance**

These operations should be programmed **annually** with a Technical Assistance Centre and are necessary to ensure the maintenance of product efficiency and ensure safe operation.

- Thoroughly clean the combustion chamber and the heat exchanger.
- Smoke motor, dismantling and cleaning of the smoke exhaust duct, new silicone where required.
- Inspection and verification of seals, replacement and silicone application where required.
- Tank, emptying and cleaning.
- Check of electrical and electronic parts.
- Cleaning and check of the tube and pressure gauge.
- Check and replacement, if necessary, of components that are subject to wear: brazier, resistance, ash drawers, etc.





Dasa-Rägister  
EN ISO 9001 (2000)  
IQ-0502-09

Laminox S.r.l.  
Zona Industriale Callarella, 261/263 – 62028 SARNANO (MC) Italy  
Tel. +39 0733.657.622 – Fax +39 0733.657.494  
[www.laminox.com](http://www.laminox.com) e-mail: [export@laminox.com](mailto:export@laminox.com)