

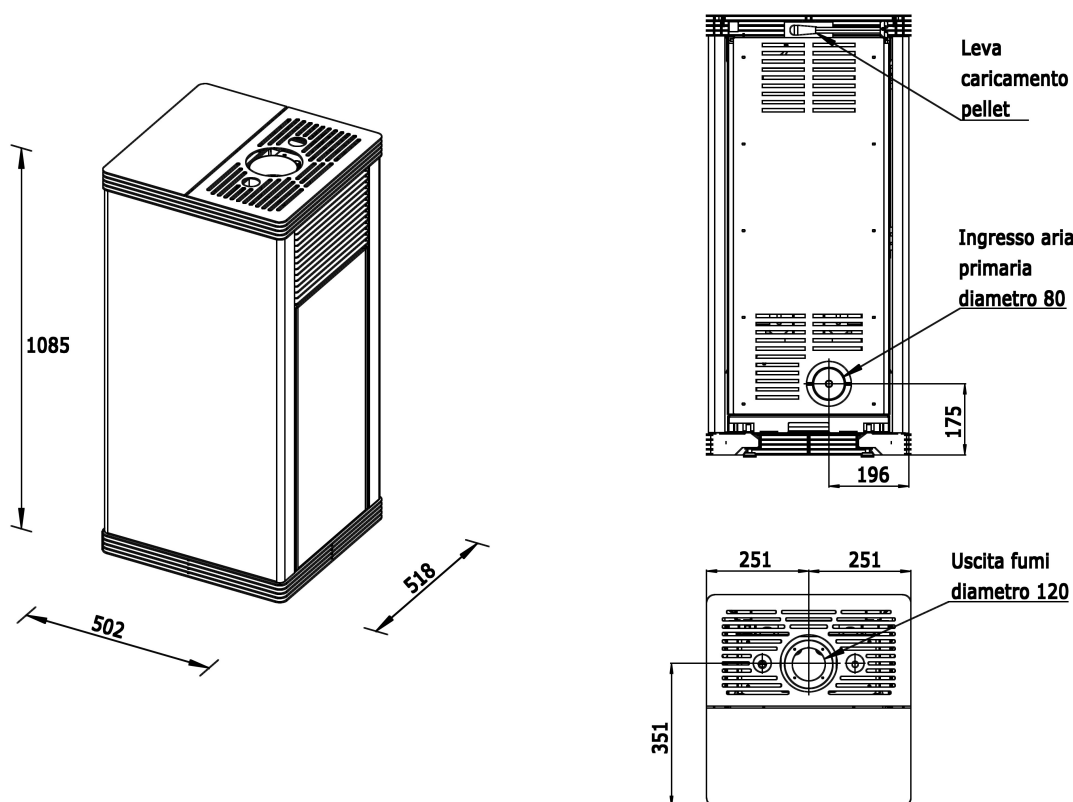

Schema tecnico / technical drawing / dessin technique / technische Zeichnung / dibujo técnico / desenho técnico



* L'estetica del prodotto potrebbe non corrispondere al modello.







 **Laminox S.r.l. si riserva il diritto di modificare senza preavviso i propri prodotti con l'intento di migliorarli senza pregiudicare le caratteristiche essenziali. I dati tecnici, e le foto pertanto non possono essere considerate un contratto nei confronti di terzi.** Per il collegamento del camino o della stufa il canale fumo deve avere un percorso più breve possibile limitando al massimo i tratti orizzontali, deve essere coibentato, non deve attraversare locali dove sia vietata l'installazione, deve prevedere un sistema di raccolta condensa e un'altezza minima di 4 mt. Inoltre lo scarico dei prodotti della combustione deve avvenire a tetto, E' vietato lo scarico diretto a parete o verso spazi chiusi anche a cielo libero. Normativa di riferimento UNI 10683-2012.

Prima del collegamento idraulico è consigliabile effettuare una pulizia dell'impianto al fine di eliminare depositi o residui di lavorazione. Collegare la termostufa o caldaia all'impianto utilizzando delle tubazioni flessibili in modo da non vincolarla eccessivamente permettendo così piccoli spostamenti. Installare sempre delle valvole a saracinesca in modo da isolare il prodotto dall'impianto e permettere eventuali operazioni di pulizia e manutenzione ordinaria e straordinaria.

 **Laminox S.r.l. reserves the right to change or modify its products without notice with the intent of improving them without affecting their essential characteristics. Technical data and photos cannot therefore be considered against third party contract.** For the connection of the fireplace or of the stove, the chimney must be as short as possible, using the minimum quantity of horizontal sections. It must be insulated, it must not pass through rooms where the installation is forbidden. A condensate collection system and a minimum height of 4 meters must be provided. Furthermore, the combustion products discharge must be directed to the roof. The direct discharge to the wall, towards enclosed spaces or in clear sky is forbidden. Refer to regulation UNI 10683-2012.

We suggest to clean the system before the hydraulic connection, in order to remove deposits and processing residues. The thermostove or boiler must be connected to the system by flexible pipes, so that they are not excessively fixed and slight movements are allowed. Always install gate valves, to allow the product to be insulated from the system and any cleaning and ordinary or extraordinary maintenance operation.

Dati tecnici / Technical characteristics / Caractéristiques techniques / Technische merkmale / Datos técnicos / Dados técnicos

							RID	NOM
Potenza termica Globale	Global thermal power	Puissance thermique Globale	Gesamte Wärmeleistung	Potencia térmica Global	Potência térmica global			8,8 kw
Potenza termica nominale	Min/Max rated thermal power	Puissance thermique nominale min/max	Min./Max. Nenn-Wärmeleistung	Potencia térmica nominal min/máx	Potência térmica nominal min/máx			2,5-7,5 kw
Potenza termica all'acqua max	Min/Max water thermal power	Puissance thermique de l'eau min/max	Min./Max. an das Wasser abgegebene Wärmeleistung	Potencia térmica del agua min/máx	Potência térmica da água min/máx			-----
Potenza termica irraggiata	Radiated thermal power	Puissance thermique rayonnée	Ausgestrahlte Wärmeleistung	Potencia térmica irradiada	Potência térmica radiada			2,5-7,5 kw
Rendimento medio	Average yield	Rendement moyen	Durchschnittliche Leistung	Rendimiento medio	Rendimento médio			85,5%
Volume riscaldabile indicativo	Indicative heatable volume	Volume de chauffage indicatif	Beheizbares Volumen (Richtwert)	Volumen calentable indicativo	Volume de Aquecimento indicativo			110-210 m ³
Particolato – OGC – NO _x (13%O ₂) mg/Nm ³	Particulate OGC – NO _x (13%O ₂) mg/Nm ³	Particule OGC – NO _x (13%O ₂) mg/Nm ³	Feinstaub OGC – NO _x (13%O ₂) mg/Nm ³	Partículas OGC – NO _x (13%O ₂) mg/Nm ³	particulado OGC – NO _x (13%O ₂) mg/Nm ³			--- / --- / ---
CO (13%O ₂)	Content of CO at 13%O ₂	teneur en CO au 13% O ₂	CO Gehalt at 13% O ₂	contenido de CO at 13% O ₂	teor de CO at 13% O ₂			0,027%0,004%
Contenuto CO ₂ (13%O ₂)	CO ₂ content (13%O ₂)	teneur en CO ₂ (13%O ₂)	CO ₂ -Gehalt (13%O ₂)	contenido de CO ₂ (13%O ₂)	teor de CO ₂ (13%O ₂)			--- ---
Tiraggio consigliato	fuel draught	Tirage de la cheminee	Zug des Kamins	Tiro medio de la chimenea	projecto de chaminé			10 – 12 Pa
Temperatura media fumi	Mean flue gas temperature	Température moyenne des fumées	Durchschn Abgasstemperatur	Temperatura media humos	Temperatura média de gás de combustão			131 / 273 °C
Consumo orario pellet kg/h	Min/max hourly pellet consumption kg/h	Consommation Horaire de pellets min/max kg/h	Min./Max. Pelletverbrauch pro Stunde kg/h	Consumo horario Pellet min/máx kg/h	Consumo horário pellets min/máx kg/h			0,6-1,9
Capacità serbatoio pellet	Tank capacity pellet	Capacité réservoir à pellets	Fassungsvermögen des Pelletbehälters	Capacidad del depósito de pellet	Capacidade do depósito de pellets			12 kg
Capacità caldaia	Boiler capacity	Capacité de la chaudière	Fassungsvermögen Heizkessel	Capacidad de la caldera	Capacidade da caldeira			-----
Scarico fumi	Fume outlet	Évacuation des fumées	Rauchabzug	Descarga de humos	Chaminé			Ø 120
Attacchi acqua	Water attachments	Raccords de l'eau	Wasseranschlüsse	Acoplamientos del agua	Ligações de água			-----
Prevalenza pompa	Pump head	Prévalence pompe	Förderhöhe Pumpe	elevación de la bomba	cabeça da bomba			-----
pressione di esercizio	working pressure	Puissance d'exercice	Betriebsdruck	presión de trabajo	pressão			-----
Alimentazione	Power supply	Alimentation	Stromversorgung	Alimentación	Alimentação			-----
Assorbimento elettrico max	Current draw max	Absorption électrique max	Stromaufnahme max	Absorción eléctrica max	Absorção eléctrica max			-----
Dimensioni LxPxH	Dimensions LxDxH	Dimensions LxPxH	Abmessungen BxTxH	Dimensiones (Largo x Ancho x Alto)	Dimensões LxPxH			572x536x1080
Peso	Weight	Poids	Gewicht	Peso	Peso			114 kg
Dimensioni forno LxPxH	Furnace dimensions LxDxH	Dimensions du four LxPxH	Ofenabmessungen BxTxH	Dimensiones del horno (Largo x Ancho x Alto)	Dimensões do forno LxPxH			-
Dimensioni porta fuoco LxH	Fire door dimensions LxH	Dimensions de la Porte du feu LxH	Abmessungen Ofentür BxH	Dimensiones de la puerta fuego (Largo x Ancho)	Dimensões da porta cortafogo			-
Dimensioni interno LxPxH	Internal dimensions LxDxH	Dimensions internes LxPxH	Innenabmessungen BxTxH	Dimensiones del Interior (Largo x Ancho)	Dimensões do interior			-
Tiraggio naturale	Natural draft	tirage naturel	natürlichem Abzug	tiro natural	tiragem natural			-
Canalizzazione	channelled ventilation	ventilation canalisé	kanalisierter Belüftung	ventilación canalizada	ventilacao canalizada			-

Tutti i dati tecnici contenuti nel presente manuale sono stati ottenuti con pellet certificato e approvato in conformità alle normative ÖM 7135

*Dati che possono variare a seconda del combustibile usato

All technical data hereby reported were collected using pellets certified and approved according to ÖM 7135 regulations.

*Data that may vary depending on the type of pellets used

Toutes les données techniques reportées ici ont été relevées en utilisant des pellets certifiés et homologués selon les normes ÖM 7135.

*Données qui peuvent varier selon le type de pellets utilisé

Alle angegebenen technischen Daten wurden mit Pelletöfen ermittelt, die gemäß der Norm ÖM 7135 zertifiziert und zugelassen sind.

* Daten können je nach verwendetem Brennstoff variieren

Todos los datos técnicos contenidos en el presente manual han sido obtenidos utilizando pellet certificado y homologado de acuerdo con las normativas ÖM 7135.

*Datos que pueden variar según el tipo de pellet utilizado

Todos os dados técnicos fornecidos foram medidos utilizando pellets certificados e homologados de acordo com as normativas ÖM 7135.

*Os dados podem variar dependendo do combustível usado